



Standard IEC 61076-2-104 M8 has 3pins, 4pins, 5pins, 6pins, 8pins. Cable assembly and PCB mount connector are available, as well as field installable. INDUS-CONNECTOR also makes customized to meet customer's requirements.

依据标准IEC 61076-2-104，M8有3芯、4芯、5芯、6芯、8芯，分为连接线、锁面板和装配式。为了满足客户需求，金达思也可以定制各类M8产品。

2 Floors, The 4th And The 5th, The 8th Bldg., Liao Industry Zone, Ainan Rd., No.78, Baolong St., Longgang Dist., Shenzhen 518116, China
深圳市龙岗区宝龙街道龙东社区爱南路78号利好工业园8栋401-501两层

www.indus-connector.com

M8 male plastic waterproof cap/M8公头塑胶防水帽

Scale drawing/尺寸图

Product photo/产品图

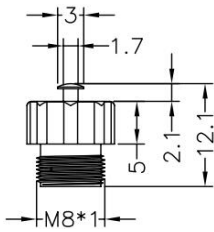

Part number/产品料号

8CAP012

General data/常规数据

Standards/标准	IEC 61076-2-104
Degree of protection/防护等级	IP67, IP68, IP69K
Screw/螺丝	Nylon/尼龙
Customs tariff number/海关编码	8538900000
Environmental compliance/环境符合标准	RoHs, Reach

M8 female plastic waterproof cap/M8母头塑胶防水帽

Scale drawing/尺寸图

Product photo/产品图

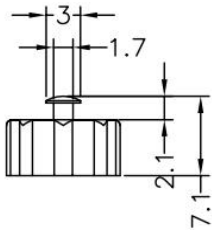

Part number/产品料号

8CAP013

General data/常规数据

Standards/标准	IEC 61076-2-104
Degree of protection/防护等级	IP67, IP68, IP69K
Gasket/胶圈	Fluorine ring/氟胶圈
Screw/螺丝	Nylon/尼龙
Customs tariff number/海关编码	8538900000
Environmental compliance/环境符合标准	RoHs, Reach

M8 male plastic waterproof cap with plastic chain/M8公头塑胶防水帽带塑胶绳

Scale drawing/尺寸图

Product photo/产品图



Part number/产品料号

8CAP014

General data/常规数据

Standards/标准	IEC 61076-2-104
Degree of protection/防护等级	IP67, IP68, IP69K
Screw/螺丝	Nylon/尼龙
Chain/绳子	Nylon/尼龙
Customs tariff number/海关编码	8538900000
Environmental compliance/环境符合标准	RoHs, Reach

M8 female plastic waterproof cap with plastic chain/M8母头塑胶防水帽带塑胶绳

Scale drawing/尺寸图

Product photo/产品图



Part number/产品料号

8CAP015

General data/常规数据

Standards/标准	IEC 61076-2-104
Degree of protection/防护等级	IP67, IP68, IP69K
Gasket/胶圈	Fluorine ring/氟胶圈
Screw/螺丝	Nylon/尼龙
Chain/绳子	Nylon/尼龙
Customs tariff number/海关编码	8538900000
Environmental compliance/环境符合标准	RoHs, Reach

M8 male metal waterproof cap/M8公头金属防水帽

Scale drawing/尺寸图

Product photo/产品图

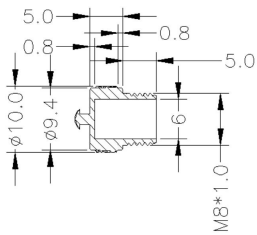

Part number/产品料号

8CAP003

General data/常规数据

Standards/标准	IEC 61076-2-104
Degree of protection/防护等级	IP67, IP68, IP69K
Screw/螺丝	Brass with nickel plated/黄铜镀镍
Customs tariff number/海关编码	8538900000
Environmental compliance/环境符合标准	RoHs, Reach

M8 female metal waterproof cap/M8母头金属防水帽

Scale drawing/尺寸图

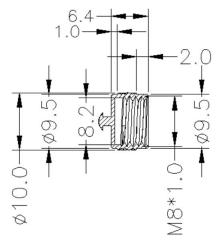

Product photo/产品图



Part number/产品料号

8CAP004

General data/常规数据

Standards/标准	IEC 61076-2-104
Degree of protection/防护等级	IP67, IP68, IP69K
Gasket/胶圈	Fluorine ring/氟胶圈
Screw/螺丝	Brass with nickel plated/黄铜镀镍
Customs tariff number/海关编码	8538900000
Environmental compliance/环境符合标准	RoHs, Reach

M8 male metal waterproof cap with stainless steel chain/M8公头防水帽带不锈钢绳

Scale drawing/尺寸图

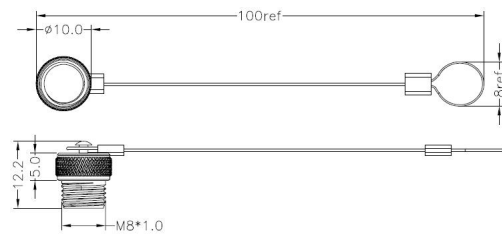

Product photo/产品图



Part number/产品料号

8CAP001-100

General data/常规数据

Standards/标准	IEC 61076-2-104
Degree of protection/防护等级	IP67, IP68, IP69K
Screw/螺丝	Brass with nickel plated/黄铜镀镍
Chain/绳子	Stainless steel/不锈钢
Customs tariff number/海关编码	8538900000
Environmental compliance/环境符合标准	RoHs, Reach

M8 female metal waterproof cap with stainless steel chain/M8母头防水帽带不锈钢绳

Scale drawing/尺寸图

Product photo/产品图

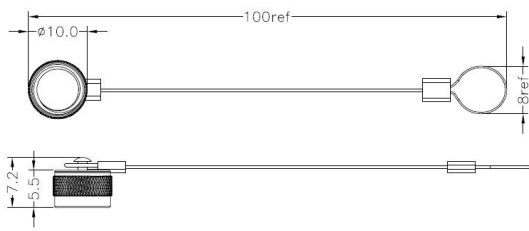

Part number/产品料号

8CAP002-100

General data/常规数据

Standards/标准	IEC 61076-2-104
Degree of protection/防护等级	IP67, IP68, IP69K
Gasket/胶圈	Fluorine ring/氟胶圈
Screw/螺丝	Brass with nickel plated/黄铜镀镍
Chain/绳子	Stainless steel/不锈钢
Customs tariff number/海关编码	8538900000
Environmental compliance/环境符合标准	RoHs, Reach

M8 male moldable connector, unshielded/M8公头成型式连接器, 不带屏蔽

Scale drawing/尺寸图

Product photo/产品图

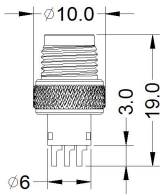

Part number/产品料号

Pins/针数	Code/型	Part number/产品料号
3pins/3针	A code/A型	8C041
4pins/4针	A code/A型	8C043
6pins/6针	A code/A型	8C047
8pins/8针	A code/A型	8C049
5pins/5针	B code/B型	8C045
4pins/4针	D code/D型	8C129

Pin assignment front view/针位分布前视图

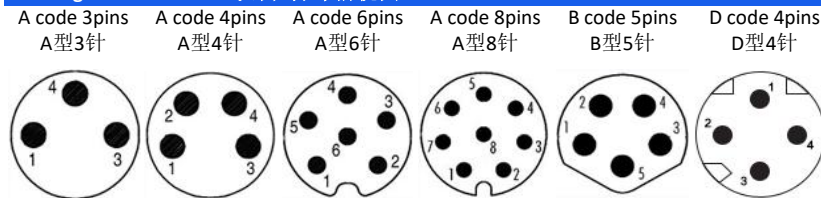

General data/常规数据

Pin numbers/针数	3pins/3针	4pins/4针	5pins/5针	6pins/6针	8pins/8针
Rated voltage/额定电压	60V	30V	30V	30V	30V
Rated current(40°C)/额定电流	3A	3A	3A	1A	1A
Standards/标准	IEC 61076-2-104				
Termination/焊接方式	Solder/焊接				
Connector locking system/锁紧方式	Screw/螺锁				
Degree of protection/防护等级	IP67, IP68, IP69K				
Wire gauge(mm²)/线规(平方数)	0.14mm²-0.34mm²			0.14mm²	
Wire gauge(AWG)/线号(平方数)	26AWG-22AWG			26AWG	
Mechanical operation/插拔次数	>100 mating cycles/大于100次				
Ambient temperature (operation)/操作温度	-25°C~+85°C				
Contact resistance/接触电阻	≤5mΩ				
Insulation resistance/绝缘电阻	≥100MΩ				
Connector body/胶芯	TPU				
Pin/端子	Brass with gold plated/黄铜镀金				
Screw/螺丝	Brass with nickel plated/黄铜镀镍				
Customs tariff number/海关编码	8538900000				
Environmental compliance/环境符合标准	RoHs, Reach				

M8 female moldable connector, unshielded/M8母头成型式连接器, 不带屏蔽

Scale drawing/尺寸图

Product photo/产品图

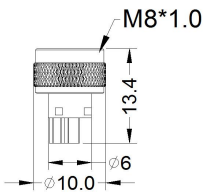

Part number/产品料号

Pins/针数	Code/型	Part number/产品料号
3pins/3孔	A code/A型	8C042
4pins/4孔	A code/A型	8C044
6pins/6孔	A code/A型	8C048
8pins/8孔	A code/A型	8C050
5pins/5孔	B code/B型	8C046
4pins/4孔	D code/D型	8C130

Pin assignment front view/孔位分布前视图

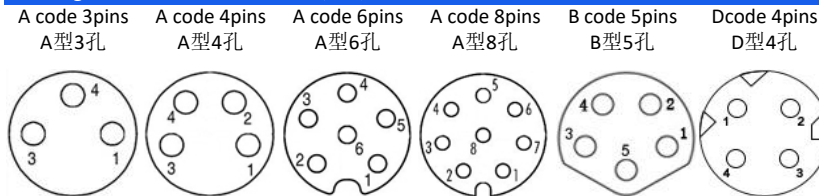

General data/常规数据

Pin numbers/孔数	3pins/3孔	4pins/4孔	5pins/5孔	6pins/6孔	8pins/8孔
Rated voltage/额定电压	60V	30V	30V	30V	30V
Rated current(40°C)/额定电流	3A	3A	3A	1A	1A
Standards/标准	IEC 61076-2-104				
Termination/焊接方式	Solder/焊接				
Connector locking system/锁紧方式	Screw/螺锁				
Degree of protection/防护等级	IP67, IP68, IP69K				
Wire gauge(mm²)/线规(平方数)	0.14mm²-0.34mm²			0.14mm²	
Wire gauge(AWG)/线号(平方数)	26AWG-22AWG			26AWG	
Mechanical operation/插拔次数	>100 mating cycles/大于100次				
Ambient temperature (operation)/操作温度	-25°C~+85°C				
Contact resistance/接触电阻	≤5mΩ				
Insulation resistance/绝缘电阻	≥100MΩ				
Connector body/胶芯	TPU				
Pin/端子	Phosphorus copper with gold plated/磷铜镀金				
Screw/螺丝	Brass with nickel plated/黄铜镀镍				
Gasket/胶圈	Fluorine ring/氟胶圈				
Customs tariff number/海关编码	8538900000				
Environmental compliance/环境符合标准	RoHs, Reach				

M8 male moldable connector with shielded/M8公头成型式连接器, 带屏蔽

Scale drawing/尺寸图

Product photo/产品图

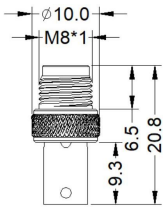

Part number/产品料号

Pins/针数	Code/型	Part number/产品料号
3pins/3针	A code/A型	8C097
4pins/4针	A code/A型	8C103
6pins/6针	A code/A型	8C057
8pins/8针	A code/A型	8C059
5pins/5针	B code/B型	8C105
4pins/4针	Dcode/D型	8C131

Pin assignment front view/针位分布前视图

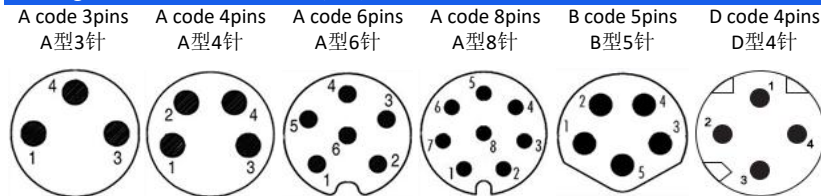

General data/常规数据

Pin numbers/针数	3pins/3针	4pins/4针	5pins/5针	6pins/6针	8pins/8针
Rated voltage/额定电压	60V	30V	30V	30V	30V
Rated current(40°C)/额定电流	3A	3A	3A	1A	1A
Standards/标准	IEC 61076-2-104				
Termination/焊接方式	Solder/焊接				
Connector locking system/锁紧方式	Screw/螺锁				
Degree of protection/防护等级	IP67, IP68, IP69K				
Wire gauge(mm²)/线规(平方数)	0.14mm²-0.34mm²			0.14mm²	
Wire gauge(AWG)/线号(平方数)	26AWG-22AWG			26AWG	
Mechanical operation/插拔次数	>100 mating cycles/大于100次				
Ambient temperature (operation)/操作温度	-25°C~+85°C				
Contact resistance/接触电阻	≤5mΩ				
Insulation resistance/绝缘电阻	≥100MΩ				
Connector body/胶芯	TPU				
Pin/端子	Brass with gold plated/黄铜镀金				
Screw/螺丝	Brass with nickel plated/黄铜镀镍				
Shielded shell/屏蔽罩	Brass with nickel plated/黄铜镀镍				
Customs tariff number/海关编码	8538900000				
Environmental compliance/环境符合标准	RoHs, Reach				

M8 female moldable connector with shielded/M8母头成型式连接器, 带屏蔽

Scale drawing/尺寸图

Product photo/产品图

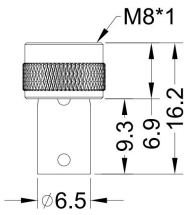

Part number/产品料号

Pins/针数	Code/型	Part number/产品料号
3pins/3孔	A code/A型	8C098
4pins/4孔	A code/A型	8C104
6pins/6孔	A code/A型	8C058
8pins/8孔	A code/A型	8C060
5pins/5孔	B code/B型	8C106
4pins/4孔	D code/D型	8C132

Pin assignment front view/孔位分布前视图

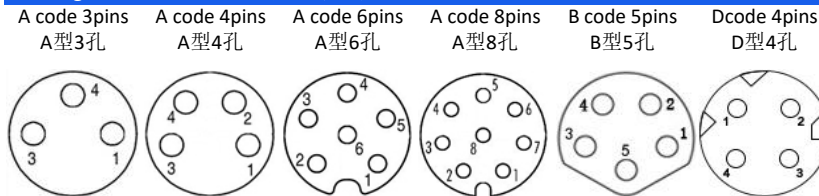

General data/常规数据

Pin numbers/孔数	3pins/3孔	4pins/4孔	5pins/5孔	6pins/6孔	8pins/8孔
Rated voltage/额定电压	60V	30V	30V	30V	30V
Rated current(40°C)/额定电流	3A	3A	3A	1A	1A
Standards/标准	IEC 61076-2-104				
Termination/焊接方式	Solder/焊接				
Connector locking system/锁紧方式	Screw/锁紧				
Degree of protection/防护等级	IP67, IP68, IP69K				
Wire gauge(mm²)/线规(平方数)	0.14mm²-0.34mm²			0.14mm²	
Wire gauge(AWG)/线号(平方数)	26AWG-22AWG			26AWG	
Mechanical operation/插拔次数	>100 mating cycles/大于100次				
Ambient temperature (operation)/操作温度	-25°C~+85°C				
Contact resistance/接触电阻	≤5mΩ				
Insulation resistance/绝缘电阻	≥100MΩ				
Connector body/胶芯	TPU				
Pin/端子	Phosphorus copper with gold plated/磷铜镀金				
Screw/螺丝	Brass with nickel plated/黄铜镀镍				
Gasket/胶圈	Fluorine ring/氟胶圈				
Shielded shell/屏蔽罩	Brass with nickel plated/黄铜镀镍				
Customs tariff number/海关编码	8538900000				
Environmental compliance/环境符合标准	RoHs, Reach				

M8 male straight front panel mount connector, unshielded, insert/M8公头直头前锁面板板端, 不带屏蔽

Scale drawing/尺寸图

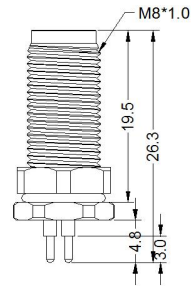

Product photo/产品图



Part number/产品料号

Pins/针数	Code/型	Part number/产品料号
3pins/3针	A code/A型	8B001
4pins/4针	A code/A型	8B005
6pins/6针	A code/A型	8B013
8pins/8针	A code/A型	8B017
5pins/5针	B code/B型	8B009
4pins/4针	D code/D型	8B073

Pin assignment front view/针位分布前视图

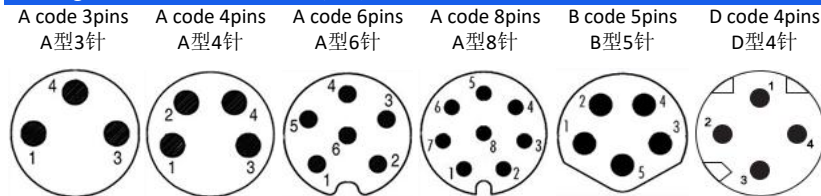

General data/常规数据

Pin numbers/针数	3pins/3针	4pins/4针	5pins/5针	6pins/6针	8pins/8针
Rated voltage/额定电压	60V	30V	30V	30V	30V
Rated current(40°C)/额定电流	3A	3A	3A	1A	1A
Standards/标准	IEC 61076-2-104				
Termination/焊接方式	Dip-solder/浸焊				
Connector locking system/锁紧方式	Screw/螺锁				
Degree of protection/防护等级	IP67, IP68, IP69K				
Mechanical operation/插拔次数	>100 mating cycles/大于100次				
Ambient temperature (operation)/操作温度	-25°C~+85°C				
Contact resistance/接触电阻	≤5mΩ				
Insulation resistance/绝缘电阻	≥100MΩ				
Connector body/胶芯	TPU				
Pin/端子	Brass with gold plated/黄铜镀金				
Nut and shell/螺母和铜壳	Brass with nickel plated/黄铜镀镍				
Gasket/胶圈	Fluorine ring/氟胶圈				
Black glue/黑色胶水	Epoxy resin/环氧树脂				
Customs tariff number/海关编码	8538900000				
Environmental compliance/环境符合标准	RoHS, Reach				

M8 male straight rear panel mount connector, unshielded, insert/M8公头直头后锁面板板端, 不带屏蔽

Scale drawing/尺寸图

Product photo/产品图

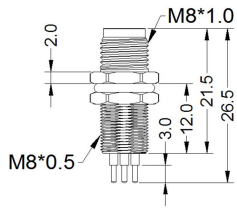

Part number/产品料号

Pins/针数	Code/型	Part number/产品料号
3pins/3针	A code/A型	8B002
4pins/4针	A code/A型	8B006
6pins/6针	A code/A型	8B014
8pins/8针	A code/A型	8B018
5pins/5针	B code/B型	8B010
4pins/4针	D code/D型	8B074

Pin assignment front view/针位分布前视图

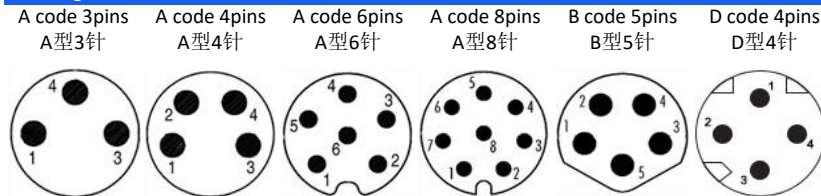

General data/常规数据

Pin numbers/针数	3pins/3针	4pins/4针	5pins/5针	6pins/6针	8pins/8针
Rated voltage/额定电压	60V	30V	30V	30V	30V
Rated current(40°C)/额定电流	3A	3A	3A	1A	1A
Standards/标准	IEC 61076-2-104				
Termination/焊接方式	Dip-solder/浸焊				
Connector locking system/锁紧方式	Screw/螺锁				
Degree of protection/防护等级	IP67, IP68, IP69K				
Mechanical operation/插拔次数	>100 mating cycles/大于100次				
Ambient temperature (operation)/操作温度	-25°C~+85°C				
Contact resistance/接触电阻	≤5mΩ				
Insulation resistance/绝缘电阻	≥100MΩ				
Connector body/胶芯	TPU				
Pin端子	Brass with gold plated/黄铜镀金				
Nut and shell/螺母和铜壳	Brass with nickel plated/黄铜镀镍				
Gasket/胶圈	Fluorine ring/氟胶圈				
Black glue/黑色胶水	Epoxy resin/环氧树脂				
Customs tariff number/海关编码	8538900000				
Environmental compliance/环境符合标准	RoHs, Reach				

M8 female straight front panel mount connector, unshielded, insert/M8母头直头前锁面板板端, 不带屏蔽

Scale drawing/尺寸图

Product photo/产品图

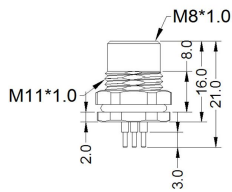

Part number/产品料号

Pins/针数	Code/型	Part number/产品料号
3pins/3孔	A code/A型	8B003
4pins/4孔	A code/A型	8B007
6pins/6孔	A code/A型	8B015
8pins/8孔	A code/A型	8B019
5pins/5孔	B code/B型	8B011
4pins/4孔	D code/D型	8B075

Pin assignment front view/孔位分布前视图

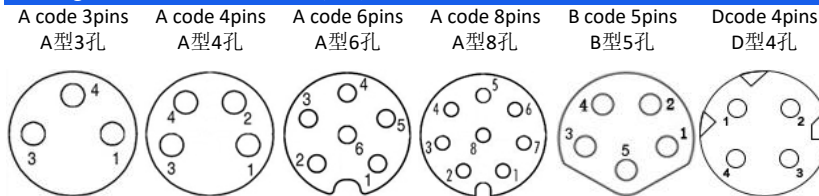

General data/常规数据

Pin numbers/孔数	3pins/3孔	4pins/4孔	5pins/5孔	6pins/6孔	8pins/8孔
Rated voltage/额定电压	60V	30V	30V	30V	30V
Rated current(40°C)/额定电流	3A	3A	3A	1A	1A
Standards/标准	IEC 61076-2-104				
Termination/焊接方式	Dip-solder/浸焊				
Connector locking system/锁紧方式	Screw/螺锁				
Degree of protection/防护等级	IP67, IP68, IP69K				
Mechanical operation/插拔次数	>100 mating cycles/大于100次				
Ambient temperature (operation)/操作温度	-25°C~+85°C				
Contact resistance/接触电阻	≤5mΩ				
Insulation resistance/绝缘电阻	≥100MΩ				
Connector body/胶芯	TPU				
Pin/端子	Phosphorus copper with gold plated/磷铜镀金				
Nut and shell/螺母和铜壳	Brass with nickel plated/黄铜镀镍				
Gasket/胶圈	Fluorine ring/氟胶圈				
Black glue/黑色胶水	Epoxy resin/环氧树脂				
Customs tariff number/海关编码	8538900000				
Environmental compliance/环境符合标准	RoHs, Reach				

M8 female straight rear panel mount connector, unshielded, insert/M8母头直头后锁面板板端, 不带屏蔽

Scale drawing/尺寸图

Product photo/产品图

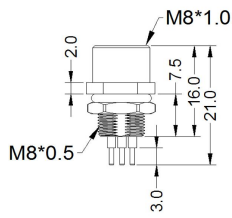

Part number/产品料号

Pins/针数	Code/型	Part number/产品料号
3pins/3孔	A code/A型	8B004
4pins/4孔	A code/A型	8B008
6pins/6孔	A code/A型	8B016
8pins/8孔	A code/A型	8B020
5pins/5孔	B code/B型	8B012
4pins/4孔	D code/D型	8B076

Pin assignment front view/孔位分布前视图

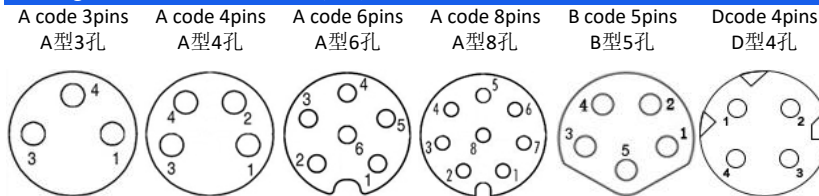

General data/常规数据

Pin numbers/孔数	3pins/3孔	4pins/4孔	5pins/5孔	6pins/6孔	8pins/8孔
Rated voltage/额定电压	60V	30V	30V	30V	30V
Rated current(40°C)/额定电流	3A	3A	3A	1A	1A
Standards/标准	IEC 61076-2-104				
Termination/焊接方式	Dip-solder/浸焊				
Connector locking system/锁紧方式	Screw/螺锁				
Degree of protection/防护等级	IP67, IP68, IP69K				
Mechanical operation/插拔次数	>100 mating cycles/大于100次				
Ambient temperature (operation)/操作温度	-25°C~+85°C				
Contact resistance/接触电阻	≤5mΩ				
Insulation resistance/绝缘电阻	≥100MΩ				
Connector body/胶芯	TPU				
Pin/端子	Phosphorus copper with gold plated/磷铜镀金				
Nut and shell/螺母和铜壳	Brass with nickel plated/黄铜镀镍				
Gasket/胶圈	Fluorine ring/氟胶圈				
Black glue/黑色胶水	Epoxy resin/环氧树脂				
Customs tariff number/海关编码	8538900000				
Environmental compliance/环境符合标准	RoHs, Reach				

M8 male straight front panel mount connector, unshielded, solder/M8公头直头前锁面板焊线式, 不带屏蔽

Scale drawing/尺寸图

Product photo/产品图

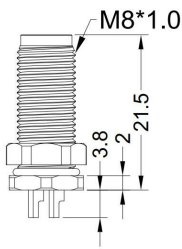

Part number/产品料号

Pins/针数	Code/型	Part number/产品料号
3pins/3针	A code/A型	8H001
4pins/4针	A code/A型	8H005
6pins/6针	A code/A型	8H013
8pins/8针	A code/A型	8H017
5pins/5针	B code/B型	8H009
4pins/4孔	D code/D型	8H026

Pin assignment front view/针位分布前视图

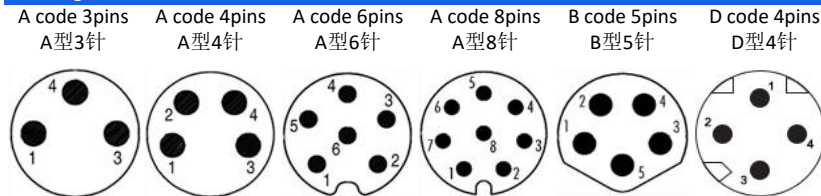

General data/常规数据

Pin numbers/针数	3pins/3针	4pins/4针	5pins/5针	6pins/6针	8pins/8针
Rated voltage/额定电压	60V	30V	30V	30V	30V
Rated current(40°C)/额定电流	3A	3A	3A	1A	1A
Standards/标准	IEC 61076-2-104				
Termination/焊接方式	Solder wires/焊线				
Connector locking system/锁紧方式	Screw/螺锁				
Degree of protection/防护等级	IP67, IP68, IP69K				
Mechanical operation/插拔次数	>100 mating cycles/大于100次				
Ambient temperature (operation)/操作温度	-25°C~+85°C				
Contact resistance/接触电阻	≤5mΩ				
Insulation resistance/绝缘电阻	≥100MΩ				
Connector body/胶芯	TPU				
Pin/端子	Brass with gold plated/黄铜镀金				
Nut and shell/螺母和铜壳	Brass with nickel plated/黄铜镀镍				
Gasket/胶圈	Fluorine ring/氟胶圈				
Black glue/黑色胶水	Epoxy resin/环氧树脂				
Customs tariff number/海关编码	8538900000				
Environmental compliance/环境符合标准	RoHs, Reach				

M8 male straight rear panel mount connector, unshielded, solder/M8公头直头后锁面板焊线式, 不带屏蔽

Scale drawing/尺寸图

Product photo/产品图

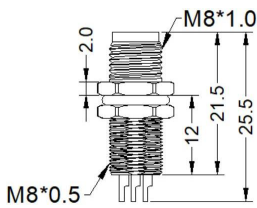

Part number/产品料号

Pins/针数	Code/型	Part number/产品料号
3pins/3针	A code/A型	8H002
4pins/4针	A code/A型	8H006
6pins/6针	A code/A型	8H014
8pins/8针	A code/A型	8H018
5pins/5针	B code/B型	8H010
4pins/4孔	D code/D型	8H027

Pin assignment front view/针位分布前视图

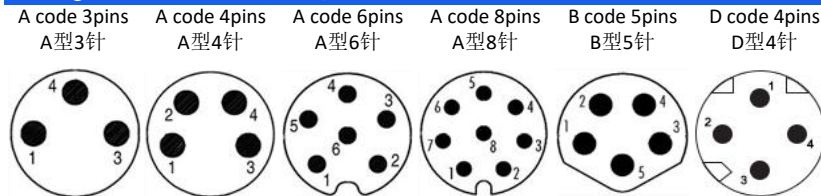

General data/常规数据

Pin numbers/针数	3pins/3针	4pins/4针	5pins/5针	6pins/6针	8pins/8针
Rated voltage/额定电压	60V	30V	30V	30V	30V
Rated current(40°C)/额定电流	3A	3A	3A	1A	1A
Standards/标准	IEC 61076-2-104				
Termination/焊接方式	Solder wires/焊线				
Connector locking system/锁紧方式	Screw/螺锁				
Degree of protection/防护等级	IP67, IP68, IP69K				
Mechanical operation/插拔次数	>100 mating cycles/大于100次				
Ambient temperature (operation)/操作温度	-25°C~+85°C				
Contact resistance/接触电阻	≤5mΩ				
Insulation resistance/绝缘电阻	≥100MΩ				
Connector body/胶芯	TPU				
Pin/端子	Brass with gold plated/黄铜镀金				
Nut and shell/螺母和铜壳	Brass with nickel plated/黄铜镀镍				
Gasket/胶圈	Fluorine ring/氟胶圈				
Black glue/黑色胶水	Epoxy resin/环氧树脂				
Customs tariff number/海关编码	8538900000				
Environmental compliance/环境符合标准	RoHs, Reach				

M8 female straight front panel mount connector, unshielded, solder/M8母头直头前锁面板焊线式, 不带屏蔽

Scale drawing/尺寸图

Product photo/产品图

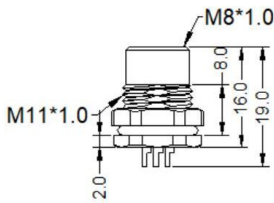

Part number/产品料号

Pins/针数	Code/型	Part number/产品料号
3pins/3孔	A code/A型	8H003
4pins/4孔	A code/A型	8H007
6pins/6孔	A code/A型	8H015
8pins/8孔	A code/A型	8H019
5pins/5孔	B code/B型	8H011
4pins/4孔	D code/D型	8H028

Pin assignment front view/孔位分布前视图

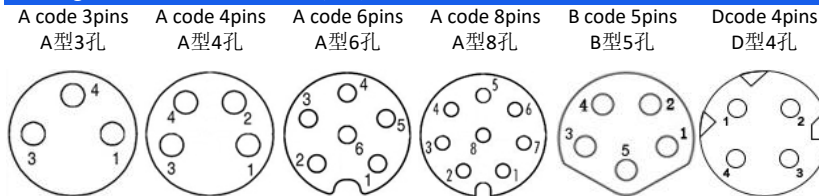

General data/常规数据

Pin numbers/孔数	3pins/3孔	4pins/4孔	5pins/5孔	6pins/6孔	8pins/8孔
Rated voltage/额定电压	60V	30V	30V	30V	30V
Rated current(40°C)/额定电流	3A	3A	3A	1A	1A
Standards/标准	IEC 61076-2-104				
Termination/焊接方式	Solder wires/焊线				
Connector locking system/锁紧方式	Screw/螺锁				
Degree of protection/防护等级	IP67, IP68, IP69K				
Mechanical operation/插拔次数	>100 mating cycles/大于100次				
Ambient temperature (operation)/操作温度	-25°C~+85°C				
Contact resistance/接触电阻	≤5mΩ				
Insulation resistance/绝缘电阻	≥100MΩ				
Connector body/胶芯	TPU				
Pin/端子	Phosphorus copper with gold plated/磷铜镀金				
Nut and shell/螺母和铜壳	Brass with nickel plated/黄铜镀镍				
Gasket/胶圈	Fluorine ring/氟胶圈				
Black glue/黑色胶水	Epoxy resin/环氧树脂				
Customs tariff number/海关编码	8538900000				
Environmental compliance/环境符合标准	RoHs, Reach				

M8 female straight rear panel mount connector, unshielded, solder/M8母头直头后锁面板焊线式, 不带屏蔽

Scale drawing/尺寸图

Product photo/产品图

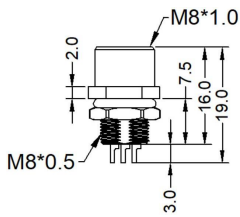

Part number/产品料号

Pins/针数	Code/型	Part number/产品料号
3pins/3孔	A code/A型	8H004
4pins/4孔	A code/A型	8H008
6pins/6孔	A code/A型	8H016
8pins/8孔	A code/A型	8H020
5pins/5孔	B code/B型	8H012
4pins/4孔	D code/D型	8H029

Pin assignment front view/孔位分布前视图

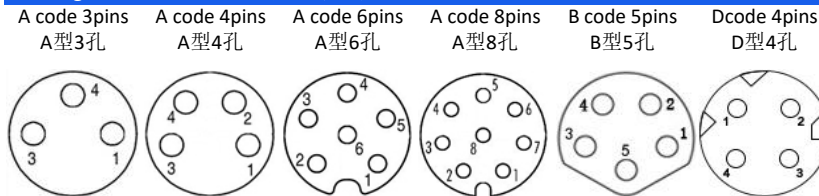

General data/常规数据

Pin numbers/孔数	3pins/3孔	4pins/4孔	5pins/5孔	6pins/6孔	8pins/8孔
Rated voltage/额定电压	60V	30V	30V	30V	30V
Rated current(40°C)/额定电流	3A	3A	3A	1A	1A
Standards/标准	IEC 61076-2-104				
Termination/焊接方式	Solder wires/焊线				
Connector locking system/锁紧方式	Screw/螺锁				
Degree of protection/防护等级	IP67, IP68, IP69K				
Mechanical operation/插拔次数	>100 mating cycles/大于100次				
Ambient temperature (operation)/操作温度	-25°C~+85°C				
Contact resistance/接触电阻	≤5mΩ				
Insulation resistance/绝缘电阻	≥100MΩ				
Connector body/胶芯	TPU				
Pin/端子	Phosphorus copper with gold plated/磷铜镀金				
Nut and shell/螺母和铜壳	Brass with nickel plated/黄铜镀镍				
Gasket/胶圈	Fluorine ring/氟胶圈				
Black glue/黑色胶水	Epoxy resin/环氧树脂				
Customs tariff number/海关编码	8538900000				
Environmental compliance/环境符合标准	RoHs, Reach				

M8 female right angle front panel mount connector, unshielded, insert/M8母头弯头前锁面板板端, 不带屏蔽

Scale drawing/尺寸图

Product photo/产品图

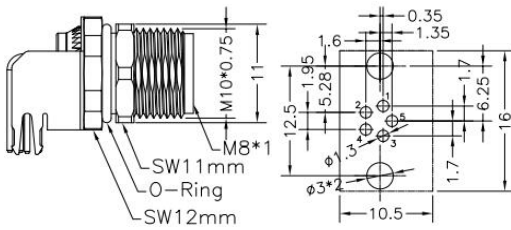

Part number/产品料号

Pins/针数	Code/型	Part number/产品料号
3pins/3孔	A code/A型	8B039
4pins/4孔	A code/A型	8B041
6pins/6孔	A code/A型	8B045
8pins/8孔	A code/A型	8B047
5pins/5孔	B code/B型	8B043

Pin assignment front view/孔位分布前视图

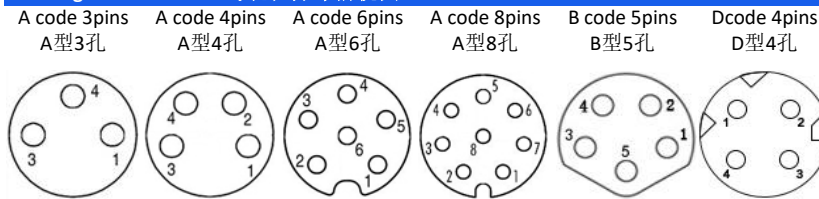

General data/常规数据

Pin numbers/孔数	3pins/3孔	4pins/4孔	5pins/5孔	6pins/6孔	8pins/8孔
Rated voltage/额定电压	60V	30V	30V	30V	30V
Rated current(40°C)/额定电流	3A	3A	3A	1A	1A
Standards/标准	IEC 61076-2-104				
Termination/焊接方式	Dip-solder/浸焊				
Connector locking system/锁紧方式	Screw/螺锁				
Degree of protection/防护等级	IP67, IP68, IP69K				
Mechanical operation/插拔次数	>100 mating cycles/大于100次				
Ambient temperature (operation)/操作温度	-25°C~+85°C				
Contact resistance/接触电阻	≤5mΩ				
Insulation resistance/绝缘电阻	≥100MΩ				
Connector body/胶芯	TPU				
Pin/端子	Phosphorus copper with gold plated/磷铜镀金				
Nut and shell/螺母和铜壳	Brass with nickel plated/黄铜镀镍				
Gasket/胶圈	Fluorine ring/氟胶圈				
Customs tariff number/海关编码	8538900000				
Environmental compliance/环境符合标准	RoHS, Reach				

M8 male straight front panel mount connector, unshielded, single wires/M8公头直头前锁面板带线, 不带屏蔽

Scale drawing/尺寸图

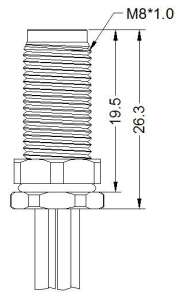

Product photo/产品图



Part number/产品料号

Pins/针数	Code/型	Part number("X" is length millimetre mm)/产品料号("X"表示长度, 单位毫米mm)
3pins/3针	A code/A型	8D001-X
4pins/4针	A code/A型	8D005-X
6pins/6针	A code/A型	8D013-X
8pins/8针	A code/A型	8D017-X
5pins/5针	B code/B型	8D009-X
4pins/4孔	D code/D型	8D071-X

Pin assignment front view/针位分布前视图

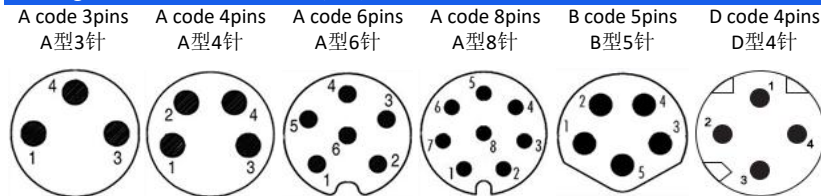

General data/常规数据

Pin numbers/针数	3pins/3针	4pins/4针	5pins/5针	6pins/6针	8pins/8针
Rated voltage/额定电压	60V	30V	30V	30V	30V
Rated current(40°C)/额定电流	3A	3A	3A	1A	1A
Standards/标准	IEC 61076-2-104				
Termination/焊接方式	With single wires/带线				
Connector locking system/锁紧方式	Screw/螺锁				
Degree of protection/防护等级	IP67, IP68, IP69K				
Wire gauge(mm²)/线规(平方数)	0.14mm²-0.34mm²			0.14mm²	
Wire gauge(AWG)/线号(平方数)	26AWG-22AWG			26AWG	
Mechanical operation/插拔次数	>100 mating cycles/大于100次				
Ambient temperature (operation)/操作温度	-25°C~+85°C				
Contact resistance/接触电阻	≤5mΩ				
Insulation resistance/绝缘电阻	≥100MΩ				
Connector body/胶芯	TPU				
Pin/端子	Brass with gold plated/黄铜镀金				
Nut and shell/螺母和铜壳	Brass with nickel plated/黄铜镀镍				
Gasket/胶圈	Fluorine ring/氟胶圈				
Black glue/黑色胶水	Epoxy resin/环氧树脂				
Customs tariff number/海关编码	8538900000				
Environmental compliance/环境符合标准	RoHs, Reach				

M8 male straight rear panel mount connector, unshielded, single wires/M8公头直头后锁面板带线, 不带屏蔽

Scale drawing/尺寸图

Product photo/产品图

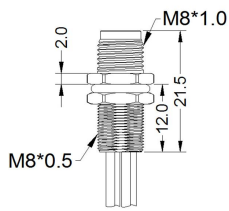

Part number/产品料号

Pins/针数	Code/型	Part number("X" is length millimetre mm)/产品料号("X"表示长度, 单位毫米mm)
3pins/3针	A code/A型	8D002-X
4pins/4针	A code/A型	8D006-X
6pins/6针	A code/A型	8D014-X
8pins/8针	A code/A型	8D018-X
5pins/5针	B code/B型	8D010-X
4pins/4孔	D code/D型	8D072-X

Pin assignment front view/针位分布前视图

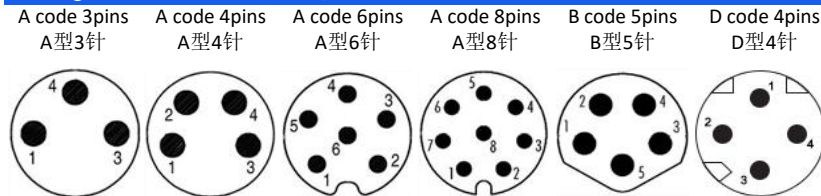

General data/常规数据

Pin numbers/针数	3pins/3针	4pins/4针	5pins/5针	6pins/6针	8pins/8针
Rated voltage/额定电压	60V	30V	30V	30V	30V
Rated current(40°C)/额定电流	3A	3A	3A	1A	1A
Standards/标准	IEC 61076-2-104				
Termination/焊接方式	With single wires/带线				
Connector locking system/锁紧方式	Screw/螺锁				
Degree of protection/防护等级	IP67, IP68, IP69K				
Wire gauge(mm²)/线规(平方数)	0.14mm²-0.34mm²			0.14mm²	
Wire gauge(AWG)/线号(平方数)	26AWG-22AWG			26AWG	
Mechanical operation/插拔次数	>100 mating cycles/大于100次				
Ambient temperature (operation)/操作温度	-25°C~+85°C				
Contact resistance/接触电阻	≤5mΩ				
Insulation resistance/绝缘电阻	≥100MΩ				
Connector body/胶芯	TPU				
Pin/端子	Brass with gold plated/黄铜镀金				
Nut and shell/螺母和铜壳	Brass with nickel plated/黄铜镀镍				
Gasket/胶圈	Fluorine ring/氟胶圈				
Black glue/黑色胶水	Epoxy resin/环氧树脂				
Customs tariff number/海关编码	8538900000				
Environmental compliance/环境符合标准	RoHs, Reach				

M8 female straight front panel mount connector, unshielded, single wires/M8母头直头前锁面板带线, 不带屏蔽

Scale drawing/尺寸图

Product photo/产品图

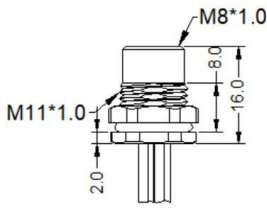

Part number/产品料号

Pins/针数	Code/型	Part number("X" is length millimetre mm)/产品料号("X"表示长度, 单位毫米mm)
3pins/3孔	A code/A型	8D003-X
4pins/4孔	A code/A型	8D007-X
6pins/6孔	A code/A型	8D015-X
8pins/8孔	A code/A型	8D019-X
5pins/5孔	B code/B型	8D011-X
4pins/4孔	D code/D型	8D073-X

Pin assignment front view/孔位分布前视图

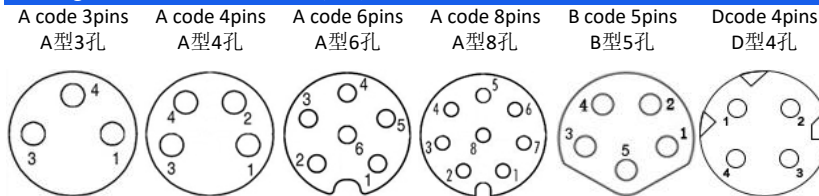

General data/常规数据

Pin numbers/孔数	3pins/3孔	4pins/4孔	5pins/5孔	6pins/6孔	8pins/8孔
Rated voltage/额定电压	60V	30V	30V	30V	30V
Rated current(40°C)/额定电流	3A	3A	3A	1A	1A
Standards/标准	IEC 61076-2-104				
Termination/焊接方式	With single wires/带线				
Connector locking system/锁紧方式	Screw/螺锁				
Degree of protection/防护等级	IP67, IP68, IP69K				
Wire gauge(mm²)/线规(平方数)	0.14mm²-0.34mm²			0.14mm²	
Wire gauge(AWG)/线号(平方数)	26AWG-22AWG			26AWG	
Mechanical operation/插拔次数	>100 mating cycles/大于100次				
Ambient temperature (operation)/操作温度	-25°C~+85°C				
Contact resistance/接触电阻	≤5mΩ				
Insulation resistance/绝缘电阻	≥100MΩ				
Connector body/胶芯	TPU				
Pin/端子	Phosphorus copper with gold plated/磷铜镀金				
Nut and shell/螺母和铜壳	Brass with nickel plated/黄铜镀镍				
Gasket/胶圈	Fluorine ring/氟胶圈				
Black glue/黑色胶水	Epoxy resin/环氧树脂				
Customs tariff number/海关编码	8538900000				
Environmental compliance/环境符合标准	RoHS, Reach				

M8 female straight rear panel mount connector, unshielded, single wires/M8母头直头后锁面板带线, 不带屏蔽

Scale drawing/尺寸图

Product photo/产品图

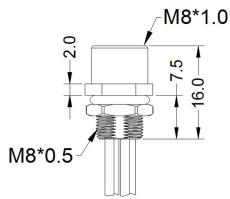

Part number/产品料号

Pins/针数	Code/型	Part number("X" is length millimetre mm)/产品料号("X"表示长度, 单位毫米mm)
3pins/3孔	A code/A型	8D004-X
4pins/4孔	A code/A型	8D008-X
6pins/6孔	A code/A型	8D016-X
8pins/8孔	A code/A型	8D020-X
5pins/5孔	B code/B型	8D012-X
4pins/4孔	D code/D型	8D074-X

Pin assignment front view/孔位分布前视图

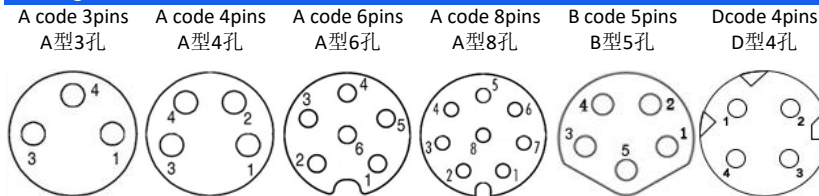

General data/常规数据

Pin numbers/孔数	3pins/3孔	4pins/4孔	5pins/5孔	6pins/6孔	8pins/8孔
Rated voltage/额定电压	60V	30V	30V	30V	30V
Rated current(40°C)/额定电流	3A	3A	3A	1A	1A
Standards/标准	IEC 61076-2-104				
Termination/焊接方式	With single wires/带线				
Connector locking system/锁紧方式	Screw/螺锁				
Degree of protection/防护等级	IP67, IP68, IP69K				
Wire gauge(mm²)/线规(平方数)	0.14mm²-0.34mm²			0.14mm²	
Wire gauge(AWG)/线号(平方数)	26AWG-22AWG			26AWG	
Mechanical operation/插拔次数	>100 mating cycles/大于100次				
Ambient temperature (operation)/操作温度	-25°C~+85°C				
Contact resistance/接触电阻	≤5mΩ				
Insulation resistance/绝缘电阻	≥100MΩ				
Connector body/胶芯	TPU				
Pin/端子	Phosphorus copper with gold plated/磷铜镀金				
Nut and shell/螺母和铜壳	Brass with nickel plated/黄铜镀镍				
Gasket/胶圈	Fluorine ring/氟胶圈				
Black glue/黑色胶水	Epoxy resin/环氧树脂				
Customs tariff number/海关编码	8538900000				
Environmental compliance/环境符合标准	RoHS, Reach				

M8 male straight plastic assembly connector, unshielded/M8公头直头塑胶装配式连接器, 不带屏蔽

Scale drawing/尺寸图

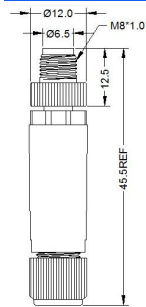

Product photo/产品图



Part number/产品料号

Pins/针数	Code/型	Part number/产品料号
3pins/3针	A code/A型	8ZU01
4pins/4针	A code/A型	8ZU03

Pin assignment front view/针位分布前视图

A code 3pins A code 4pins
 A型3针 A型4针

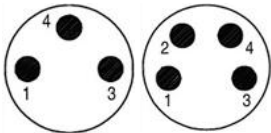

General data/常规数据

Pin numbers/针数	3pins/3针	4pins/4针
Rated voltage/额定电压	60V	30V
Rated current(40°C)/额定电流	3A	3A
Standards/标准	IEC 61076-2-104	
Termination/焊接方式	Screw clamp/螺锁	
Connector locking system/锁紧方式	Screw/螺锁	
Degree of protection/防护等级	IP67, IP68, IP69K	
Wire gauge(mm²)/线规(平方数)	0.14mm²-0.34mm²	
Wire gauge(AWG)/线号(平方数)	26AWG-22AWG	
Suitable cable outer diameter/适合线材外径	3.5mm-5.0mm	
Mechanical operation/插拔次数	>100 mating cycles/大于100次	
Ambient temperature(operation)/操作温度	-25°C~+85°C	
Contact resistance/接触电阻	≤5mΩ	
Insulation resistance/绝缘电阻	≥100MΩ	
Connector body/胶芯	TPU	
Pin/端子	Brass with gold plated/黄铜镀金	
Screw/螺丝	Brass with nickel plated/黄铜镀镍	
Gasket/胶圈	Fluorine ring/氟胶圈	
Customs tariff number/海关编码	8538900000	
Environmental compliance/环境符合标准	RoHS, Reach	

M8 male right angle plastic assembly connector, unshielded/M8公头弯头塑胶装配式连接器, 不带屏蔽

Scale drawing/尺寸图

Product photo/产品图

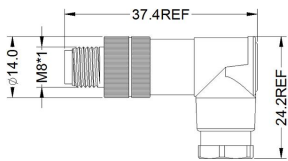

Part number/产品料号

Pins/针数	Code/型	Part number/产品料号
3pins/3针	A code/A型	8ZU05
4pins/4针	A code/A型	8ZU07

Pin assignment front view/针位分布前视图

A code 3pins A code 4pins
 A型3针 A型4针

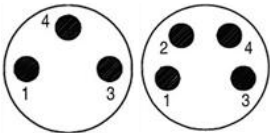

General data/常规数据

Pin numbers/针数	3pins/3针	4pins/4针
Rated voltage/额定电压	60V	30V
Rated current(40°C)/额定电流	3A	3A
Standards/标准	IEC 61076-2-104	
Termination/焊接方式	Screw clamp/螺锁	
Connector locking system/锁紧方式	Screw/螺锁	
Degree of protection/防护等级	IP67, IP68, IP69K	
Wire gauge(mm²)/线规(平方数)	0.14mm²-0.34mm²	
Wire gauge(AWG)/线号(平方数)	26AWG-22AWG	
Suitable cable outer diameter/适合线材外径	3.5mm-5.0mm	
Mechanical operation/插拔次数	>100 mating cycles/大于100次	
Ambient temperature(operation)/操作温度	-25°C~+85°C	
Contact resistance/接触电阻	≤5mΩ	
Insulation resistance/绝缘电阻	≥100MΩ	
Connector body/胶芯	TPU	
Pin/端子	Brass with gold plated/黄铜镀金	
Screw/螺丝	Brass with nickel plated/黄铜镀镍	
Gasket/胶圈	Fluorine ring/氟胶圈	
Customs tariff number/海关编码	8538900000	
Environmental compliance/环境符合标准	RoHS, Reach	

M8 female straight plastic assembly connector, unshielded/M8母头直头塑胶装配式连接器, 不带屏蔽

Scale drawing/尺寸图

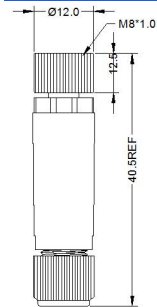

Product photo/产品图



Part number/产品料号

Pins/针数	Code/型	Part number/产品料号
3pins/3孔	A code/A型	8ZU02
4pins/4孔	A code/A型	8ZU04

Pin assignment front view/孔位分布前视图

A code 3pins A code 4pins
A型3孔 A型4孔

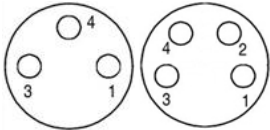

General data/常规数据

Pin numbers/孔数	3pins/3孔	4pins/4孔
Rated voltage/额定电压	60V	30V
Rated current(40°C)/额定电流	3A	3A
Standards/标准	IEC 61076-2-104	
Termination/焊接方式	Screw clamp/螺锁	
Connector locking system/锁紧方式	Screw/螺锁	
Degree of protection/防护等级	IP67, IP68, IP69K	
Wire gauge(mm²)/线规(平方数)	0.14mm²-0.34mm²	
Wire gauge(AWG)/线号(平方数)	26AWG-22AWG	
Suitable cable outer diameter/适合线材外径	3.5mm-5.0mm	
Mechanical operation/插拔次数	>100 mating cycles/大于100次	
Ambient temperature(operation)/操作温度	-25°C~+85°C	
Contact resistance/接触电阻	≤5mΩ	
Insulation resistance/绝缘电阻	≥100MΩ	
Connector body/胶芯	TPU	
Pin/端子	Phosphorus copper with gold plated/磷铜镀金	
Screw/螺丝	Brass with nickel plated/黄铜镀镍	
Gasket/胶圈	Fluorine ring/氟胶圈	
Customs tariff number/海关编码	8538900000	
Environmental compliance/环境符合标准	RoHs, Reach	

M8 female right angle plastic assembly connector, unshielded/M8母头弯头塑胶装配式连接器, 不带屏蔽

Scale drawing/尺寸图

Product photo/产品图

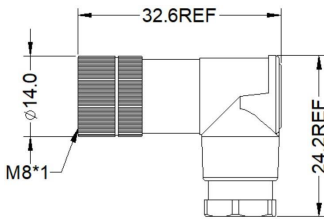

Part number/产品料号

Pins/针数	Code/型	Part number/产品料号
3pins/3孔	A code/A型	8ZU06
4pins/4孔	A code/A型	8ZU08

Pin assignment front view/孔位分布前视图

A code 3pins A code 4pins
A型3孔 A型4孔

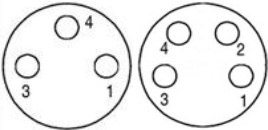

General data/常规数据

Pin numbers/针数	3pins/3孔	4pins/4孔
Rated voltage/额定电压	60V	30V
Rated current(40°C)/额定电流	3A	3A
Standards/标准	IEC 61076-2-104	
Termination/焊接方式	Screw clamp/螺锁	
Connector locking system/锁紧方式	Screw/螺锁	
Degree of protection/防护等级	IP67, IP68, IP69K	
Wire gauge(mm²)/线规(平方数)	0.14mm²-0.34mm²	
Wire gauge(AWG)/线号(平方数)	26AWG-22AWG	
Suitable cable outer diameter/适合线材外径	3.5mm-5.0mm	
Mechanical operation/插拔次数	>100 mating cycles/大于100次	
Ambient temperature(operation)/操作温度	-25°C~+85°C	
Contact resistance/接触电阻	≤5mΩ	
Insulation resistance/绝缘电阻	≥100MΩ	
Connector body/胶芯	TPU	
Pin/端子	Phosphorus copper with gold plated/磷铜镀金	
Screw/螺丝	Brass with nickel plated/黄铜镀镍	
Gasket/胶圈	Fluorine ring/氟胶圈	
Customs tariff number/海关编码	8538900000	
Environmental compliance/环境符合标准	RoHS, Reach	

M8 male straight metal assembly connector, shielded/M8公头直头金属装配式连接器, 带屏蔽

Scale drawing/尺寸图

Product photo/产品图

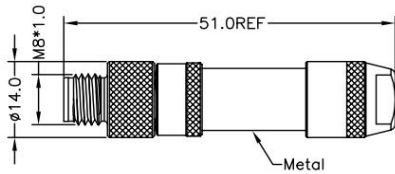

Part number/产品料号

Pins/针数	Code/型	Part number/产品料号
3pins/3针	A code/A型	8ZS01
4pins/4针	A code/A型	8ZS03

Pin assignment front view/针位分布前视图

A code 3pins A code 4pins
A型3针 A型4针

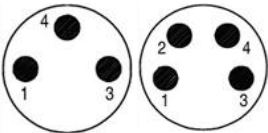

General data/常规数据

Pin numbers/针数	3pins/3针	4pins/4针
Rated voltage/额定电压	60V	30V
Rated current(40°C)/额定电流	3A	3A
Standards/标准	IEC 61076-2-104	
Termination/焊接方式	Screw clamp/螺锁	
Connector locking system/锁紧方式	Screw/螺锁	
Degree of protection/防护等级	IP67, IP68, IP69K	
Wire gauge(mm²)/线规(平方数)	0.14mm²-0.34mm²	
Wire gauge(AWG)/线号(平方数)	26AWG-22AWG	
Suitable cable outer diameter/适合线材外径	3.5mm-5.0mm	
Mechanical operation/插拔次数	>100 mating cycles/大于100次	
Ambient temperature(operation)/操作温度	-25°C~+85°C	
Contact resistance/接触电阻	≤5mΩ	
Insulation resistance/绝缘电阻	≥100MΩ	
Connector body/胶芯	TPU	
Pin/端子	Brass with gold plated/黄铜镀金	
Screw/螺丝	Brass with nickel plated/黄铜镀镍	
Gasket/胶圈	Fluorine ring/氟胶圈	
Customs tariff number/海关编码	8538900000	
Environmental compliance/环境符合标准	RoHS, Reach	

M8 female straight metal assembly connector, shielded/M8母头直头金属装配式连接器, 带屏蔽

Scale drawing/尺寸图

Product photo/产品图

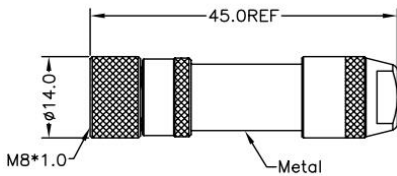

Part number/产品料号

Pins/针数	Code/型	Part number/产品料号
3pins/3孔	A code/A型	8ZS02
4pins/4孔	A code/A型	8ZS04

Pin assignment front view/针位分布前视图

A code 3pins A code 4pins
A型3孔 A型4孔

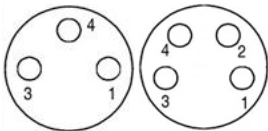

General data/常规数据

Pin numbers/孔数	3pins/3孔	4pins/4孔
Rated voltage/额定电压	60V	30V
Rated current(40°C)/额定电流	3A	3A
Standards/标准	IEC 61076-2-104	
Termination/焊接方式	Screw clamp/螺锁	
Connector locking system/锁紧方式	Screw/螺锁	
Degree of protection/防护等级	IP67, IP68, IP69K	
Wire gauge(mm²)/线规(平方数)	0.14mm²-0.34mm²	
Wire gauge(AWG)/线号(平方数)	26AWG-22AWG	
Suitable cable outer diameter/适合线材外径	3.5mm-5.0mm	
Mechanical operation/插拔次数	>100 mating cycles/大于100次	
Ambient temperature(operation)/操作温度	-25°C~+85°C	
Contact resistance/接触电阻	≤5mΩ	
Insulation resistance/绝缘电阻	≥100MΩ	
Connector body/胶芯	TPU	
Pin/端子	Phosphorus copper with gold plated/磷铜镀金	
Screw/螺丝	Brass with nickel plated/黄铜镀镍	
Gasket/胶圈	Fluorine ring/氟胶圈	
Customs tariff number/海关编码	8538900000	
Environmental compliance/环境符合标准	RoHS, Reach	

M8 male straight molded cable, unshielded/M8公头直头成型式连接线, 不带屏蔽

Scale drawing/尺寸图

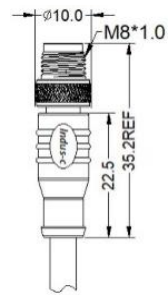

Product photo/产品图



Part number/产品料号

Pins/针数	Code/型	Part number("X" is length millimetre mm)/产品料号("X"表示长度, 单位毫米mm)			
		PVC jacket/PVC外被		PUR jacket/PUR外被	
		-10°C~+80°C	-40°C~+105°C	-40°C~+105°C	
3pins/3针	A code/A型	8L00002-X	8L00051-X	8L00052-X	
4pins/4针	A code/A型	8L00029-X	8L00057-X	8L00058-X	
6pins/6针	A code/A型	8L00064-X	8L00022-X	8L00067-X	
8pins/8针	A code/A型	8L00073-X	8L00074-X	8L00075-X	
5pins/5针	B code/B型	8L00085-X	8L00086-X	8L00087-X	
4pins/4针	D code/D型	8L00517-X	8L00518-X	8L00519-X	

Pin assignment front view/针位分布前视图

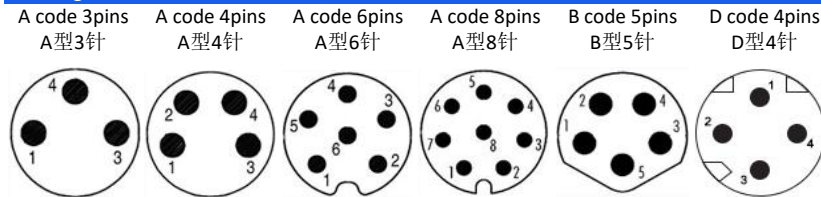

General data/常规数据

Pin numbers/针数	3pins/3针	4pins/4针	5pins/5针	6pins/6针	8pins/8针
Rated voltage/额定电压	60V	30V	30V	30V	30V
Rated current(40°C)/额定电流	3A	3A	3A	1A	1A
Standards/标准	IEC 61076-2-104				
Termination/焊接方式	Solder and over-mold/焊接和成型				
Connector locking system/锁紧方式	Screw/螺锁				
Degree of protection/防护等级	IP67, IP68, IP69K				
Wire gauge(mm²)/线规(平方数)	0.14mm²-0.34mm²			0.14mm²	
Wire gauge(AWG)/线号(平方数)	26AWG-22AWG			26AWG	
Mechanical operation/插拔次数	>100 mating cycles/大于100次				
Ambient temperature(operation)/操作温度	-25°C~+85°C				
Contact resistance/接触电阻	≤5mΩ				
Insulation resistance/绝缘电阻	≥100MΩ				
Connector body/胶芯	TPU				
Pin/端子	Brass with gold plated/黄铜镀金				
Screw/螺丝	Brass with nickel plated/黄铜镀镍				
Over-mold/成型	TPU				
Customs tariff number/海关编码	8518900001				
Environmental compliance/环境符合标准	RoHs, Reach				

M8 female straight molded cable, unshielded/M8母头直头成型式连接线, 不带屏蔽

Scale drawing/尺寸图

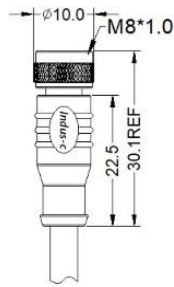

Product photo/产品图



Part number/产品料号

Pins/针数	Code/型	Part number("X" is length millimetre mm)/产品料号("X"表示长度, 单位毫米mm)			
		PVC jacket/PVC外被		PUR jacket/PUR外被	
		-10°C~+80°C	-40°C~+105°C	-40°C~+105°C	
3pins/3孔	A code/A型	8L00055-X	8L00056-X	8L00047-X	
4pins/4孔	A code/A型	8L00041-X	8L00061-X	8L00048-X	
6pins/6孔	A code/A型	8L00068-X	8L00023-X	8L00069-X	
8pins/8孔	A code/A型	8L00079-X	8L00080-X	8L00081-X	
5pins/5孔	B code/B型	8L00091-X	8L00092-X	8L00093-X	
4pins/4针	D code/D型	8L00520-X	8L00521-X	8L00522-X	

Pin assignment front view/孔位分布前视图

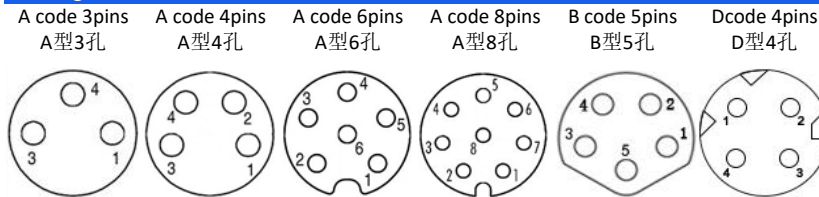

General data/常规数据

Pin numbers/针数	3pins/3孔	4pins/4孔	5pins/5孔	6pins/6孔	8pins/8孔
Rated voltage/额定电压	60V	30V	30V	30V	30V
Rated current(40°C)/额定电流	3A	3A	3A	1A	1A
Standards/标准	IEC 61076-2-104				
Termination/焊接方式	Solder and over-mold/焊接和成型				
Connector locking system/锁紧方式	Screw/螺锁				
Degree of protection/防护等级	IP67, IP68, IP69K				
Wire gauge(mm²)/线规(平方数)	0.14mm²-0.34mm²			0.14mm²	
Wire gauge(AWG)/线号(平方数)	26AWG-22AWG			26AWG	
Mechanical operation/插拔次数	>100 mating cycles/大于100次				
Ambient temperature(operation)/操作温度	-25°C~+85°C				
Contact resistance/接触电阻	≤5mΩ				
Insulation resistance/绝缘电阻	≥100MΩ				
Connector body/胶芯	TPU				
Pin/端子	Phosphorus copper with gold plated/磷铜镀金				
Screw/螺丝	Brass with nickel plated/黄铜镀镍				
Over-mold/成型	TPU				
Gasket/胶圈	Fluorine ring/氟胶圈				
Customs tariff number/海关编码	8518900001				
Environmental compliance/环境符合标准	RoHS, Reach				

M8 male right angle molded cable, unshielded/M8公头弯头成型式连接线, 不带屏蔽

Scale drawing/尺寸图

Product photo/产品图

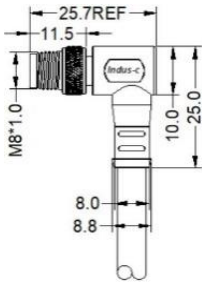

Part number/产品料号

Pins/针数	Code/型	Part number("X" is length millimetre mm)/产品料号("X"表示长度, 单位毫米mm)			
		PVC jacket/PVC外被		PUR jacket/PUR外被	
		-10°C~+80°C	-40°C~+105°C	-40°C~+105°C	
3pins/3针	A code/A型	8L00040-X	8L00053-X	8L00054-X	
4pins/4针	A code/A型	8L00042-X	8L00059-X	8L00060-X	
6pins/6针	A code/A型	8L00065-X	8L00066-X	8L00028-X	
8pins/8针	A code/A型	8L00076-X	8L00077-X	8L00078-X	
5pins/5针	B code/B型	8L00088-X	8L00089-X	8L00090-X	
4pins/4针	D code/D型	8L00523-X	8L00524-X	8L00525-X	

Pin assignment front view/针位分布前视图

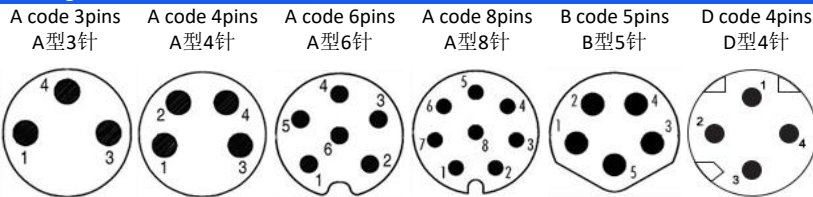

General data/常规数据

Pin numbers/针数	3pins/3针	4pins/4针	5pins/5针	6pins/6针	8pins/8针
Rated voltage/额定电压	60V	30V	30V	30V	30V
Rated current(40°C)/额定电流	3A	3A	3A	1A	1A
Standards/标准	IEC 61076-2-104				
Termination/焊接方式	Solder and over-mold/焊接和成型				
Connector locking system/锁紧方式	Screw/螺锁				
Degree of protection/防护等级	IP67, IP68, IP69K				
Wire gauge(mm²)/线规(平方数)	0.14mm²-0.34mm²			0.14mm²	
Wire gauge(AWG)/线号(平方数)	26AWG-22AWG			26AWG	
Mechanical operation/插拔次数	>100 mating cycles/大于100次				
Ambient temperature(operation)/操作温度	-25°C~+85°C				
Contact resistance/接触电阻	≤5mΩ				
Insulation resistance/绝缘电阻	≥100MΩ				
Connector body/胶芯	TPU				
Pin/端子	Brass with gold plated/黄铜镀金				
Screw/螺丝	Brass with nickel plated/黄铜镀镍				
Over-mold/成型	TPU				
Customs tariff number/海关编码	8518900001				
Environmental compliance/环境符合标准	RoHS, Reach				

M8 female right angle molded cable, unshielded/M8母头弯头成型式连接线, 不带屏蔽

Scale drawing/尺寸图

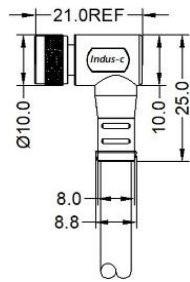

Product photo/产品图



Part number/产品料号

Pins/针数	Code/型	Part number("X" is length millimetre mm)/产品料号("X"表示长度, 单位毫米mm)			
		PVC jacket/PVC外被		PUR jacket/PUR外被	
		-10°C~+80°C	-40°C~+105°C	-40°C~+105°C	
3pins/3孔	A code/A型	8L00038-X	8L00046-X	8L00049-X	
4pins/4孔	A code/A型	8L00035-X	8L00062-X	8L00063-X	
6pins/6孔	A code/A型	8L00070-X	8L00071-X	8L00072-X	
8pins/8孔	A code/A型	8L00082-X	8L00083-X	8L00084-X	
5pins/5孔	B code/B型	8L00094-X	8L00095-X	8L00096-X	
4pins/4针	D code/D型	8L00526-X	8L00527-X	8L00528-X	

Pin assignment front view/孔位分布前视图

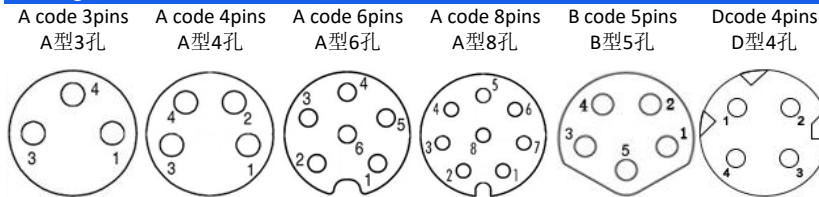

General data/常规数据

Pin numbers/孔数	3pins/3孔	4pins/4孔	5pins/5孔	6pins/6孔	8pins/8孔
Rated voltage/额定电压	60V	30V	30V	30V	30V
Rated current(40°C)/额定电流	3A	3A	3A	1A	1A
Standards/标准	IEC 61076-2-104				
Termination/焊接方式	Solder and over-mold/焊接和成型				
Connector locking system/锁紧方式	Screw/螺锁				
Degree of protection/防护等级	IP67, IP68, IP69K				
Wire gauge(mm²)/线规(平方数)	0.14mm²-0.34mm²			0.14mm²	
Wire gauge(AWG)/线号(平方数)	26AWG-22AWG			26AWG	
Mechanical operation/插拔次数	>100 mating cycles/大于100次				
Ambient temperature(operation)/操作温度	-25°C~+85°C				
Contact resistance/接触电阻	≤5mΩ				
Insulation resistance/绝缘电阻	≥100MΩ				
Connector body/胶芯	TPU				
Pin/端子	Phosphorus copper with gold plated/磷铜镀金				
Screw/螺丝	Brass with nickel plated/黄铜镀镍				
Over-mold/成型	TPU				
Gasket/胶圈	Fluorine ring/氟胶圈				
Customs tariff number/海关编码	8518900001				
Environmental compliance/环境符合标准	RoHS, Reach				

M8 male straight molded cable, shielded/M8公头直头成型式连接线, 带屏蔽

Scale drawing/尺寸图

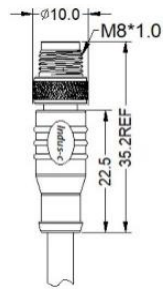

Product photo/产品图



Part number/产品料号

Pins/针数	Code/型	Part number("X" is length millimetre mm)/产品料号("X"表示长度, 单位毫米mm)			
		PVC jacket/PVC外被		PUR jacket/PUR外被	
		-10°C~+80°C	-40°C~+105°C	-40°C~+105°C	
3pins/3针	A code/A型	8L00097-X	8L00098-X	8L00099-X	
4pins/4针	A code/A型	8L00109-X	8L00110-X	8L00111-X	
6pins/6针	A code/A型	8L00030-X	8L00039-X	8L00121-X	
8pins/8针	A code/A型	8L00031-X	8L00045-X	8L00131-X	
5pins/5针	B code/B型	8L00141-X	8L00142-X	8L00143-X	
4pins/4针	D code/D型	8L00529-X	8L00530-X	8L00531-X	

Pin assignment front view/针位分布前视图

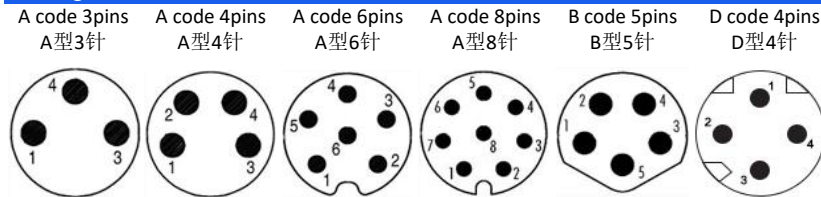

General data/常规数据

Pin numbers/针数	3pins/3针	4pins/4针	5pins/5针	6pins/6针	8pins/8针
Rated voltage/额定电压	60V	30V	30V	30V	30V
Rated current(40°C)/额定电流	3A	3A	3A	1A	1A
Standards/标准	IEC 61076-2-104				
Termination/焊接方式	Solder and over-mold/焊接和成型				
Connector locking system/锁紧方式	Screw/螺锁				
Degree of protection/防护等级	IP67, IP68, IP69K				
Wire gauge(mm²)/线规(平方数)	0.14mm²-0.34mm²			0.14mm²	
Wire gauge(AWG)/线号(平方数)	26AWG-22AWG			26AWG	
Mechanical operation/插拔次数	>100 mating cycles/大于100次				
Ambient temperature(operation)/操作温度	-25°C~+85°C				
Contact resistance/接触电阻	≤5mΩ				
Insulation resistance/绝缘电阻	≥100MΩ				
Connector body/胶芯	TPU				
Pin/端子	Brass with gold plated/黄铜镀金				
Screw/螺丝	Brass with nickel plated/黄铜镀镍				
Over-mold/成型	TPU				
Shielded sheath/屏蔽罩	Brass with nickel plated/黄铜镀镍				
Customs tariff number/海关编码	8518900001				
Environmental compliance/环境符合标准	RoHS, Reach				

M8 female straight molded cable, shielded/M8母头直头成型式连接线, 带屏蔽

Scale drawing/尺寸图

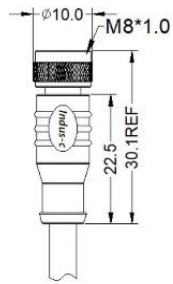

Product photo/产品图



Part number/产品料号

Pins/针数	Code/型	Part number("X" is length millimetre mm)/产品料号("X"表示长度, 单位毫米mm)			
		PVC jacket/PVC外被		PUR jacket/PUR外被	
		-10°C~+80°C	-40°C~+105°C	-40°C~+105°C	
3pins/3孔	A code/A型	8L00103-X	8L00104-X	8L00105-X	
4pins/4孔	A code/A型	8L00115-X	8L00116-X	8L00117-X	
6pins/6孔	A code/A型	8L00125-X	8L00126-X	8L00127-X	
8pins/8孔	A code/A型	8L00135-X	8L00136-X	8L00137-X	
5pins/5孔	B code/B型	8L00147-X	8L00148-X	8L00149-X	
4pins/4针	D code/D型	8L00532-X	8L00533-X	8L00534-X	

Pin assignment front view/孔位分布前视图

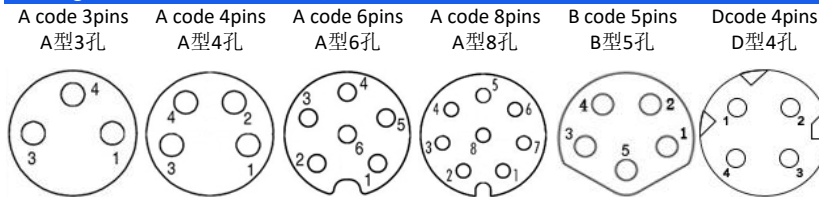

General data/常规数据

Pin numbers/孔数	3pins/3孔	4pins/4孔	5pins/5孔	6pins/6孔	8pins/8孔
Rated voltage/额定电压	60V	30V	30V	30V	30V
Rated current(40°C)/额定电流	3A	3A	3A	1A	1A
Standards/标准	IEC 61076-2-104				
Termination/焊接方式	Solder and over-mold/焊接和成型				
Connector locking system/锁紧方式	Screw/螺锁				
Degree of protection/防护等级	IP67, IP68, IP69K				
Wire gauge(mm²)/线规(平方数)	0.14mm²-0.34mm²			0.14mm²	
Wire gauge(AWG)/线号(平方数)	26AWG-22AWG			26AWG	
Mechanical operation/插拔次数	>100 mating cycles/大于100次				
Ambient temperature(operation)/操作温度	-25°C~+85°C				
Contact resistance/接触电阻	≤5mΩ				
Insulation resistance/绝缘电阻	≥100MΩ				
Connector body/胶芯	TPU				
Pin/端子	Phosphorus copper with gold plated/磷铜镀金				
Screw/螺丝	Brass with nickel plated/黄铜镀镍				
Over-mold/成型	TPU				
Shielded sheath/屏蔽罩	Brass with nickel plated/黄铜镀镍				
Gasket/胶圈	Fluorine ring/氟胶圈				
Customs tariff number/海关编码	851890001				
Environmental compliance/环境符合标准	RoHs, Reach				

M8 male right angle molded cable, shielded/M8公头弯头成型式连接线, 带屏蔽

Scale drawing/尺寸图

Product photo/产品图

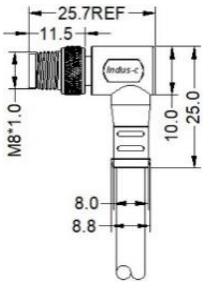

Part number/产品料号

Pins/针数	Code/型	Part number("X" is length millimetre mm)/产品料号("X"表示长度, 单位毫米mm)			
		PVC jacket/PVC外被		PUR jacket/PUR外被	
		-10°C~+80°C	-40°C~+105°C	-40°C~+105°C	
3pins/3针	A code/A型	8L00100-X	8L00101-X	8L00102-X	
4pins/4针	A code/A型	8L00112-X	8L00113-X	8L00114-X	
6pins/6针	A code/A型	8L00122-X	8L00123-X	8L00124-X	
8pins/8针	A code/A型	8L00132-X	8L00133-X	8L00134-X	
5pins/5针	B code/B型	8L00144-X	8L00145-X	8L00146-X	
4pins/4针	D code/D型	8L00535-X	8L00536-X	8L00537-X	

Pin assignment front view/针位分布前视图

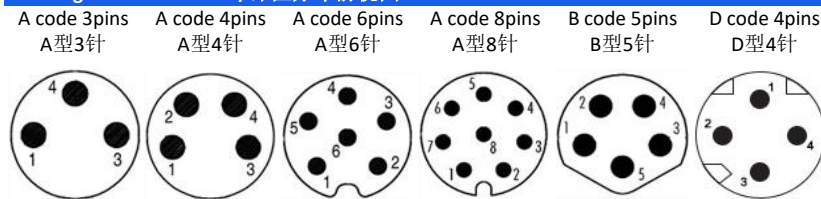

General data/常规数据

Pin numbers/针数	3pins/3针	4pins/4针	5pins/5针	6pins/6针	8pins/8针
Rated voltage/额定电压	60V	30V	30V	30V	30V
Rated current(40°C)/额定电流	3A	3A	3A	1A	1A
Standards/标准	IEC 61076-2-104				
Termination/焊接方式	Solder and over-mold/焊接和成型				
Connector locking system/锁紧方式	Screw/螺锁				
Degree of protection/防护等级	IP67, IP68, IP69K				
Wire gauge(mm²)/线规(平方数)	0.14mm²-0.34mm²			0.14mm²	
Wire gauge(AWG)/线号(平方数)	26AWG-22AWG			26AWG	
Mechanical operation/插拔次数	>100 mating cycles/大于100次				
Ambient temperature(operation)/操作温度	-25°C~+85°C				
Contact resistance/接触电阻	≤5mΩ				
Insulation resistance/绝缘电阻	≥100MΩ				
Connector body/胶芯	TPU				
Pin/端子	Brass with gold plated/黄铜镀金				
Screw/螺丝	Brass with nickel plated/黄铜镀镍				
Over-mold/成型	TPU				
Shielded sheath/屏蔽罩	Brass with nickel plated/黄铜镀镍				
Customs tariff number/海关编码	8518900001				
Environmental compliance/环境符合标准	RoHS, Reach				

M8 female right angle molded cable, shielded/M8母头弯头成型式连接线, 带屏蔽

Scale drawing/尺寸图

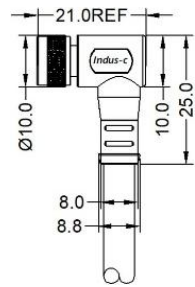

Product photo/产品图



Part number/产品料号

Pins/针数	Code/型	Part number("X" is length millimetre mm)/产品料号("X"表示长度, 单位毫米mm)			
		PVC jacket/PVC外被		PUR jacket/PUR外被	
		-10°C~+80°C	-40°C~+105°C	-40°C~+105°C	
3pins/3孔	A code/A型	8L00106-X	8L00107-X	8L00108-X	
4pins/4孔	A code/A型	8L00118-X	8L00119-X	8L00120-X	
6pins/6孔	A code/A型	8L00128-X	8L00129-X	8L00130-X	
8pins/8孔	A code/A型	8L00138-X	8L00139-X	8L00140-X	
5pins/5孔	B code/B型	8L00150-X	8L00151-X	8L00152-X	
4pins/4针	D code/D型	8L00538-X	8L00539-X	8L00540-X	

Pin assignment front view/孔位分布前视图

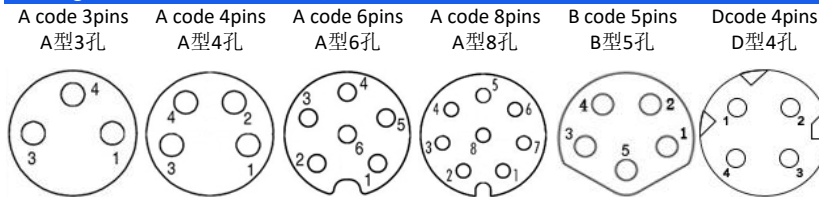

General data/常规数据

Pin numbers/孔数	3pins/3孔	4pins/4孔	5pins/5孔	6pins/6孔	8pins/8孔
Rated voltage/额定电压	60V	30V	30V	30V	30V
Rated current(40°C)/额定电流	3A	3A	3A	1A	1A
Standards/标准	IEC 61076-2-104				
Termination/焊接方式	Solder and over-mold/焊接和成型				
Connector locking system/锁紧方式	Screw/螺锁				
Degree of protection/防护等级	IP67, IP68, IP69K				
Wire gauge(mm²)/线规(平方数)	0.14mm²-0.34mm²			0.14mm²	
Wire gauge(AWG)/线号(平方数)	26AWG-22AWG			26AWG	
Mechanical operation/插拔次数	>100 mating cycles/大于100次				
Ambient temperature(operation)/操作温度	-25°C~+85°C				
Contact resistance/接触电阻	≤5mΩ				
Insulation resistance/绝缘电阻	≥100MΩ				
Connector body/胶芯	TPU				
Pin/端子	Phosphorus copper with gold plated/磷铜镀金				
Screw/螺丝	Brass with nickel plated/黄铜镀镍				
Over-mold/成型	TPU				
Shielded sheath/屏蔽罩	Brass with nickel plated/黄铜镀镍				
Gasket/胶圈	Fluorine ring/氟胶圈				
Customs tariff number/海关编码	851890001				
Environmental compliance/环境符合标准	RoHs, Reach				

M8 code male to male right angle molded cable, unshielded/M8公头弯头对公头弯头连接线, 不带屏蔽

Scale drawing/尺寸图

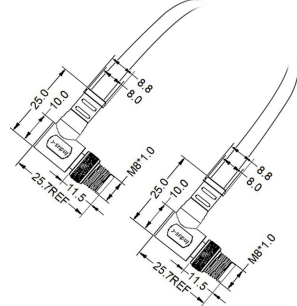

Product photo/产品图



Part number/产品料号

Pins/针数	Code/型	Part number("X" is length millimetre mm)/产品料号("X"表示长度, 单位毫米mm)			
		PVC jacket/PVC外被		PUR jacket/PUR外被	
		-10°C~+80°C	-40°C~+105°C	-40°C~+105°C	
3pins/3孔	A code/A型	8L00034-X	8L00181-X	8L00182-X	
4pins/4孔	A code/A型	8L00239-X	8L00240-X	8L00241-X	
6pins/6孔	A code/A型	8L00355-X	8L00356-X	8L00357-X	
8pins/8孔	A code/A型	8L00415-X	8L00416-X	8L00417-X	
5pins/5孔	B code/B型	8L00296-X	8L00297-X	8L00298-X	
4pins/4针	D code/D型	8L00541-X	8L00542-X	8L00543-X	

Pin assignment front view/孔位分布前视图

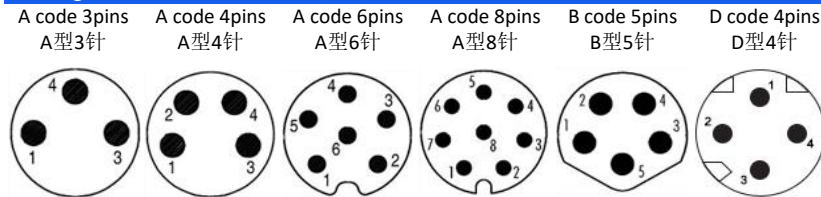

General data/常规数据

Pin numbers/孔数	3pins/3孔	4pins/4孔	5pins/5孔	6pins/6孔	8pins/8孔
Rated voltage/额定电压	60V	30V	30V	30V	30V
Rated current(40°C)/额定电流	3A	3A	3A	1A	1A
Standards/标准	IEC 61076-2-104				
Termination/焊接方式	Solder and over-mold/焊接和成型				
Connector locking system/锁紧方式	Screw/螺锁				
Degree of protection/防护等级	IP67, IP68, IP69K				
Wire gauge(mm²)/线规(平方数)	0.14mm²-0.34mm²			0.14mm²	
Wire gauge(AWG)/线号(平方数)	26AWG-22AWG			26AWG	
Mechanical operation/插拔次数	>100 mating cycles/大于100次				
Ambient temperature(operation)/操作温度	-25°C~+85°C				
Contact resistance/接触电阻	≤5mΩ				
Insulation resistance/绝缘电阻	≥100MΩ				
Connector body/胶芯	TPU				
Pin/端子	Brass with gold plated/黄铜镀金				
Screw/螺丝	Brass with nickel plated/黄铜镀镍				
Over-mold/成型	TPU				
Gasket/胶圈	Fluorine ring/氟胶圈				
Customs tariff number/海关编码	8518900001				
Environmental compliance/环境符合标准	RoHS, Reach				

M8 male to female right angle molded cable, unshielded/M8公对母弯头成型式连接线, 不带屏蔽

Scale drawing/尺寸图

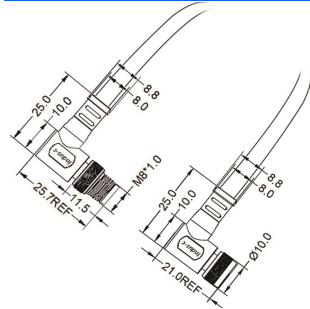

Product photo/产品图



Part number/产品料号

Pins/针数	Code/型	Part number("X" is length millimetre mm)/产品料号("X"表示长度, 单位毫米mm)			
		PVC jacket/PVC外被		PUR jacket/PUR外被	
		-10°C~+80°C	-40°C~+105°C	-40°C~+105°C	
3pins/3孔	A code/A型	8L00161-X	8L00162-X	8L00163-X	
4pins/4孔	A code/A型	8L00218-X	8L00219-X	8L00220-X	
6pins/6孔	A code/A型	8L00334-X	8L00335-X	8L00336-X	
8pins/8孔	A code/A型	8L00394-X	8L00395-X	8L00396-X	
5pins/5孔	B code/B型	8L00275-X	8L00276-X	8L00277-X	
4pins/4针	D code/D型	8L00544-X	8L00545-X	8L00546-X	

Pin assignment front view/孔位分布前视图

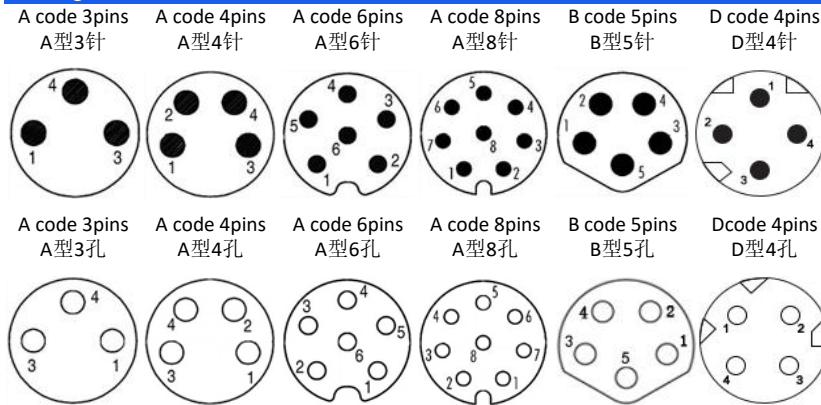

General data/常规数据

Pin numbers/孔数	3pins/3孔	4pins/4孔	5pins/5孔	6pins/6孔	8pins/8孔
Rated voltage/额定电压	60V	30V	30V	30V	30V
Rated current(40°C)/额定电流	3A	3A	3A	1A	1A
Standards/标准	IEC 61076-2-104				
Termination/焊接方式	Solder and over-mold/焊接和成型				
Connector locking system/锁紧方式	Screw/螺锁				
Degree of protection/防护等级	IP67, IP68, IP69K				
Wire gauge(mm²)/线规(平方数)	0.14mm²-0.34mm²			0.14mm²	
Wire gauge(AWG)/线号(平方数)	26AWG-22AWG			26AWG	
Mechanical operation/插拔次数	>100 mating cycles/大于100次				
Ambient temperature(operation)/操作温度	-25°C~+85°C				
Contact resistance/接触电阻	≤5mΩ				
Connector body/胶芯	TPU				
Male pin/公端子	Brass with gold plated/黄铜镀金				
Female pin/端子	Phosphorus copper with gold plated/磷铜镀金				
Screw/螺丝	Brass with nickel plated/黄铜镀镍				
Over-mold/成型	TPU				
Customs tariff number/海关编码	8518900001				
Environmental compliance/环境符合标准	RoHs, Reach				

M8 male right angle to female straight molded cable, unshielded/M8公头弯头对母头直头成型式连接线, 不带屏蔽

Scale drawing/尺寸图

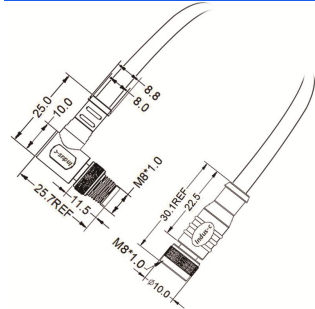

Product photo/产品图



Part number/产品料号

Pins/针数	Code/型	Part number("X" is length millimetre mm)/产品料号("X"表示长度, 单位毫米mm)			
		PVC jacket/PVC外被		PUR jacket/PUR外被	
		-10°C~+80°C	-40°C~+105°C	-40°C~+105°C	
3pins/3孔	A code/A型	8L00166-X	8L00167-X	8L00168-X	
4pins/4孔	A code/A型	8L00224-X	8L00225-X	8L00226-X	
6pins/6孔	A code/A型	8L00340-X	8L00341-X	8L00342-X	
8pins/8孔	A code/A型	8L00400-X	8L00401-X	8L00402-X	
5pins/5孔	B code/B型	8L00281-X	8L00282-X	8L00283-X	
4pins/4针	D code/D型	8L00547-X	8L00548-X	8L00549-X	

Pin assignment front view/孔位分布前视图

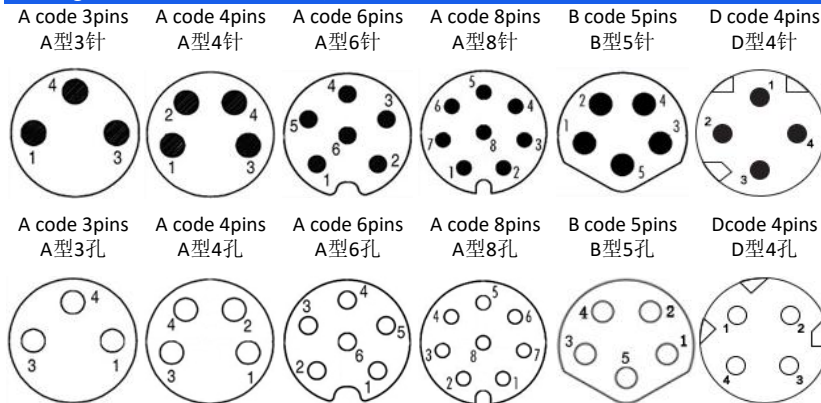

General data/常规数据

Pin numbers/孔数	3pins/3孔	4pins/4孔	5pins/5孔	6pins/6孔	8pins/8孔
Rated voltage/额定电压	60V	30V	30V	30V	30V
Rated current(40°C)/额定电流	3A	3A	3A	1A	1A
Standards/标准	IEC 61076-2-104				
Connector locking system/锁紧方式	Screw/螺锁				
Degree of protection/防护等级	IP67, IP68, IP69K				
Wire gauge(mm²)/线规(平方数)	0.14mm²-0.34mm²			0.14mm²	
Wire gauge(AWG)/线号(平方数)	26AWG-22AWG			26AWG	
Mechanical operation/插拔次数	>100 mating cycles/大于100次				
Contact resistance/接触电阻	≤5mΩ				
Insulation resistance/绝缘电阻	≥100MΩ				
Connector body/胶芯	TPU				
Male pin/公端子	Brass with gold plated/黄铜镀金				
Female pin/母端子	Phosphorus copper with gold plated/磷铜镀金				
Screw/螺丝	Brass with nickel plated/黄铜镀镍				
Over-mold/成型	TPU				
Customs tariff number/海关编码	8518900001				
Environmental compliance/环境符合标准	RoHs, Reach				

M8 code male straight to male right angle molded cable, unshielded/M8公头直头对公头弯头连接线, 不带屏蔽

Scale drawing/尺寸图

Product photo/产品图

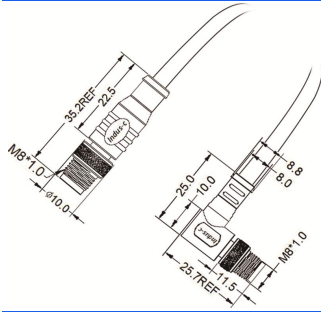

Part number/产品料号

Pins/针数	Code/型	Part number("X" is length millimetre mm)/产品料号("X"表示长度, 单位毫米mm)			
		PVC jacket/PVC外被		PUR jacket/PUR外被	
		-10°C~+80°C	-40°C~+105°C	-40°C~+105°C	
3pins/3孔	A code/A型	8L00172-X	8L00173-X	8L00174-X	
4pins/4孔	A code/A型	8L00230-X	8L00231-X	8L00232-X	
6pins/6孔	A code/A型	8L00346-X	8L00347-X	8L00348-X	
8pins/8孔	A code/A型	8L00406-X	8L00407-X	8L00408-X	
5pins/5孔	B code/B型	8L00287-X	8L00288-X	8L00289-X	
4pins/4针	D code/D型	8L00550-X	8L00551-X	8L00552-X	

Pin assignment front view/孔位分布前视图

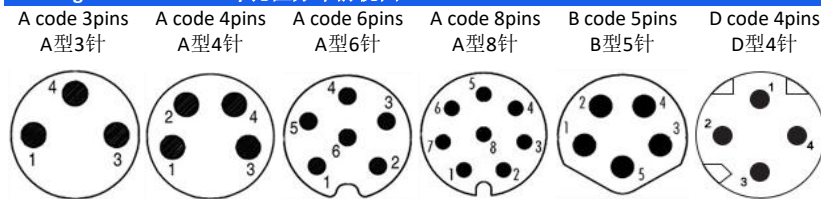

General data/常规数据

Pin numbers/孔数	3pins/3孔	4pins/4孔	5pins/5孔	6pins/6孔	8pins/8孔
Rated voltage/额定电压	60V	30V	30V	30V	30V
Rated current(40°C)/额定电流	3A	3A	3A	1A	1A
Standards/标准	IEC 61076-2-104				
Termination/焊接方式	Solder and over-mold/焊接和成型				
Connector locking system/锁紧方式	Screw/螺锁				
Degree of protection/防护等级	IP67, IP68, IP69K				
Wire gauge(mm²)/线规(平方数)	0.14mm²-0.34mm²			0.14mm²	
Wire gauge(AWG)/线号(平方数)	26AWG-22AWG			26AWG	
Mechanical operation/插拔次数	>100 mating cycles/大于100次				
Ambient temperature(operation)/操作温度	-25°C~+85°C				
Contact resistance/接触电阻	≤5mΩ				
Insulation resistance/绝缘电阻	≥100MΩ				
Connector body/胶芯	TPU				
Pin/端子	Brass with gold plated/黄铜镀金				
Screw/螺丝	Brass with nickel plated/黄铜镀镍				
Over-mold/成型	TPU				
Gasket/胶圈	Fluorine ring/氟胶圈				
Customs tariff number/海关编码	8518900001				
Environmental compliance/环境符合标准	RoHS, Reach				

M8 code male to male straight molded cable, unshielded/M8公头直头对公头直头连接线, 不带屏蔽

Scale drawing/尺寸图

Product photo/产品图

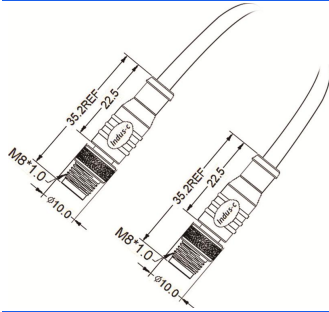

Part number/产品料号

Pins/针数	Code/型	Part number("X" is length millimetre mm)/产品料号("X"表示长度, 单位毫米mm)			
		PVC jacket/PVC外被		PUR jacket/PUR外被	
		-10°C~+80°C	-40°C~+105°C	-40°C~+105°C	
3pins/3孔	A code/A型	8L00169-X	8L00170-X	8L00171-X	
4pins/4孔	A code/A型	8L00227-X	8L00228-X	8L00229-X	
6pins/6孔	A code/A型	8L00343-X	8L00344-X	8L00345-X	
8pins/8孔	A code/A型	8L00403-X	8L00404-X	8L00405-X	
5pins/5孔	B code/B型	8L00284-X	8L00285-X	8L00286-X	
4pins/4针	D code/D型	8L00553-X	8L00554-X	8L00555-X	

Pin assignment front view/孔位分布前视图

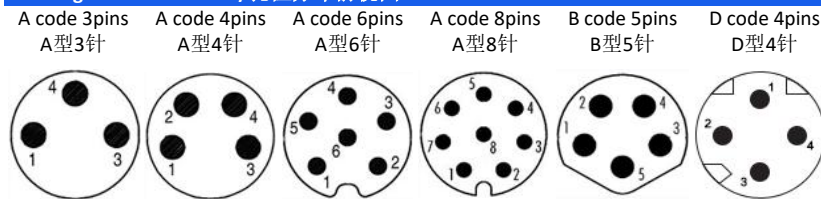

General data/常规数据

Pin numbers/孔数	3pins/3孔	4pins/4孔	5pins/5孔	6pins/6孔	8pins/8孔
Rated voltage/额定电压	60V	30V	30V	30V	30V
Rated current(40°C)/额定电流	3A	3A	3A	1A	1A
Standards/标准	IEC 61076-2-104				
Termination/焊接方式	Solder and over-mold/焊接和成型				
Connector locking system/锁紧方式	Screw/螺锁				
Degree of protection/防护等级	IP67, IP68, IP69K				
Wire gauge(mm²)/线规(平方数)	0.14mm²-0.34mm²			0.14mm²	
Wire gauge(AWG)/线号(平方数)	26AWG-22AWG			26AWG	
Mechanical operation/插拔次数	>100 mating cycles/大于100次				
Ambient temperature(operation)/操作温度	-25°C~+85°C				
Contact resistance/接触电阻	≤5mΩ				
Insulation resistance/绝缘电阻	≥100MΩ				
Connector body/胶芯	TPU				
Pin/端子	Brass with gold plated/黄铜镀金				
Screw/螺丝	Brass with nickel plated/黄铜镀镍				
Over-mold/成型	TPU				
Gasket/胶圈	Fluorine ring/氟胶圈				
Customs tariff number/海关编码	8518900001				
Environmental compliance/环境符合标准	RoHS, Reach				

M8 male straight to female right angle molded cable, unshielded/M8公头直头对母头弯头成型式连接线, 不带屏蔽

Scale drawing/尺寸图

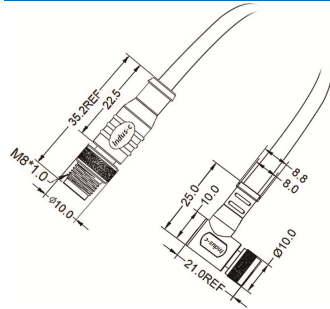

Product photo/产品图



Part number/产品料号

Pins/针数	Code/型	Part number("X" is length millimetre mm)/产品料号("X"表示长度, 单位毫米mm)			
		PVC jacket/PVC外被		PUR jacket/PUR外被	
		-10°C~+80°C	-40°C~+105°C	-40°C~+105°C	
3pins/3孔	A code/A型	8L00037-X	8L00164-X	8L00165-X	
4pins/4孔	A code/A型	8L00221-X	8L00222-X	8L00223-X	
6pins/6孔	A code/A型	8L00337-X	8L00338-X	8L00339-X	
8pins/8孔	A code/A型	8L00397-X	8L00398-X	8L00399-X	
5pins/5孔	B code/B型	8L00278-X	8L00279-X	8L00280-X	
4pins/4针	D code/D型	8L00556-X	8L00557-X	8L00558-X	

Pin assignment front view/孔位分布前视图

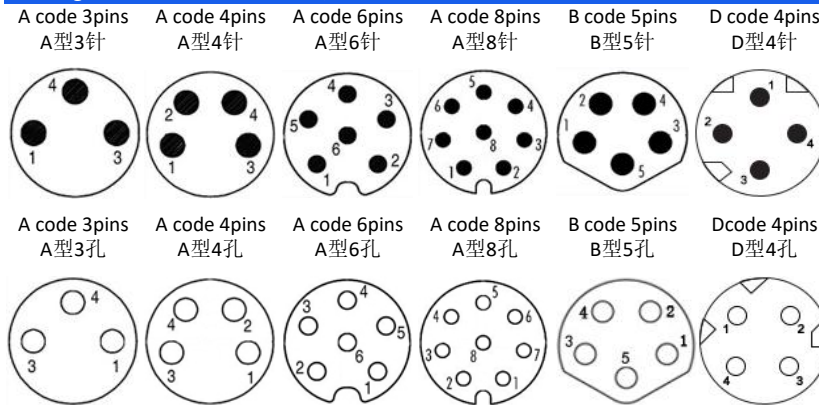

General data/常规数据

Pin numbers/孔数	3pins/3孔	4pins/4孔	5pins/5孔	6pins/6孔	8pins/8孔
Rated voltage/额定电压	60V	30V	30V	30V	30V
Rated current(40°C)/额定电流	3A	3A	3A	1A	1A
Standards/标准	IEC 61076-2-104				
Connector locking system/锁紧方式	Screw/螺锁				
Degree of protection/防护等级	IP67, IP68, IP69K				
Ambient temperature(operation)/操作温度	-25°C~+85°C				
Contact resistance/接触电阻	≤5mΩ				
Insulation resistance/绝缘电阻	≥100MΩ				
Connector body/胶芯	TPU				
Male pin/公端子	Brass with gold plated/黄铜镀金				
Screw/螺丝	Brass with nickel plated/黄铜镀镍				
Over-mold/成型	TPU				
Customs tariff number/海关编码	8518900001				
Environmental compliance/环境符合标准	RoHS, Reach				

M8 male to female straight molded cable, unshielded/M8公对母直头成型式连接线, 不带屏蔽

Scale drawing/尺寸图

Product photo/产品图

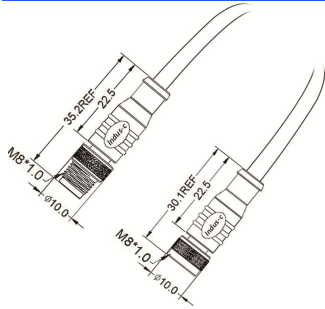

Part number/产品料号

Pins/针数	Code/型	Part number("X" is length millimetre mm)/产品料号("X"表示长度, 单位毫米mm)			
		PVC jacket/PVC外被		PUR jacket/PUR外被	
		-10°C~+80°C	-40°C~+105°C	-40°C~+105°C	
3pins/3孔	A code/A型	8L00159-X	8L00160-X	8L00026-X	
4pins/4孔	A code/A型	8L00215-X	8L00216-X	8L00217-X	
6pins/6孔	A code/A型	8L00021-X	8L00332-X	8L00333-X	
8pins/8孔	A code/A型	8L00391-X	8L00392-X	8L00393-X	
5pins/5孔	B code/B型	8L00272-X	8L00273-X	8L00274-X	
4pins/4针	D code/D型	8L00559-X	8L00560-X	8L00561-X	

Pin assignment front view/孔位分布前视图

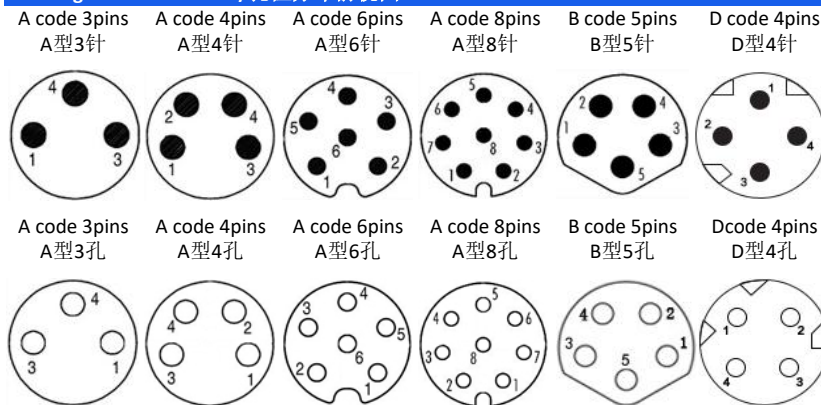

General data/常规数据

Pin numbers/孔数	3pins/3孔	4pins/4孔	5pins/5孔	6pins/6孔	8pins/8孔
Rated voltage/额定电压	60V	30V	30V	30V	30V
Rated current(40°C)/额定电流	3A	3A	3A	1A	1A
Standards/标准	IEC 61076-2-104				
Connector locking system/锁紧方式	Screw/螺锁				
Degree of protection/防护等级	IP67, IP68, IP69K				
Wire gauge(mm²)/线规(平方数)	0.14mm²-0.34mm²			0.14mm²	
Wire gauge(AWG)/线号(平方数)	26AWG-22AWG			26AWG	
Mechanical operation/插拔次数	>100 mating cycles/大于100次				
Ambient temperature(operation)/操作温度	-25°C~+85°C				
Contact resistance/接触电阻	≤5mΩ				
Insulation resistance/绝缘电阻	≥100MΩ				
Connector body/胶芯	TPU				
Male pin/公端子	Brass with gold plated/黄铜镀金				
Female pin/母端子	Phosphorus copper with gold plated/磷铜镀金				
Screw/螺丝	Brass with nickel plated/黄铜镀镍				
Over-mold/成型	TPU				
Customs tariff number/海关编码	8518900001				
Environmental compliance/环境符合标准	RoHS, Reach				

M8 code female to female right angle molded cable, unshielded/M8母头弯头对母头弯头连接线, 不带屏蔽

Scale drawing/尺寸图

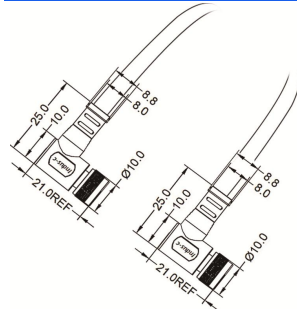

Product photo/产品图



Part number/产品料号

Pins/针数	Code/型	Part number("X" is length millimetre mm)/产品料号("X"表示长度, 单位毫米mm)			
		PVC jacket/PVC外被		PUR jacket/PUR外被	
		-10°C~+80°C	-40°C~+105°C	-40°C~+105°C	
3pins/3孔	A code/A型	8L00183-X	8L00184-X	8L00185-X	
4pins/4孔	A code/A型	8L00242-X	8L00243-X	8L00244-X	
6pins/6孔	A code/A型	8L00358-X	8L00359-X	8L00360-X	
8pins/8孔	A code/A型	8L00418-X	8L00419-X	8L00420-X	
5pins/5孔	B code/B型	8L00299-X	8L00300-X	8L00301-X	
4pins/4针	D code/D型	8L00562-X	8L00563-X	8L00564-X	

Pin assignment front view/孔位分布前视图

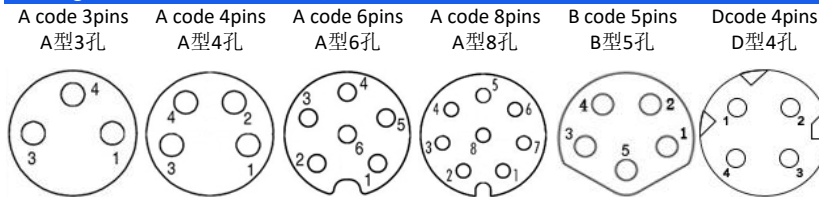

General data/常规数据

Pin numbers/孔数	3pins/3孔	4pins/4孔	5pins/5孔	6pins/6孔	8pins/8孔
Rated voltage/额定电压	60V	30V	30V	30V	30V
Rated current(40°C)/额定电流	3A	3A	3A	1A	1A
Standards/标准	IEC 61076-2-104				
Termination/焊接方式	Solder and over-mold/焊接和成型				
Connector locking system/锁紧方式	Screw/螺锁				
Degree of protection/防护等级	IP67, IP68, IP69K				
Wire gauge(mm²)/线规(平方数)	0.14mm²-0.34mm²			0.14mm²	
Wire gauge(AWG)/线号(平方数)	26AWG-22AWG			26AWG	
Mechanical operation/插拔次数	>100 mating cycles/大于100次				
Ambient temperature(operation)/操作温度	-25°C~+85°C				
Contact resistance/接触电阻	≤5mΩ				
Insulation resistance/绝缘电阻	≥100MΩ				
Connector body/胶芯	TPU				
Pin/端子	Phosphorus copper with gold plated/磷铜镀金				
Screw/螺丝	Brass with nickel plated/黄铜镀镍				
Over-mold/成型	TPU				
Gasket/胶圈	Fluorine ring/氟胶圈				
Customs tariff number/海关编码	8518900001				
Environmental compliance/环境符合标准	RoHS, Reach				

M8 code female straight to female right angle molded cable, unshielded/M8母头直头对母头弯头连接线, 不带屏蔽

Scale drawing/尺寸图

Product photo/产品图

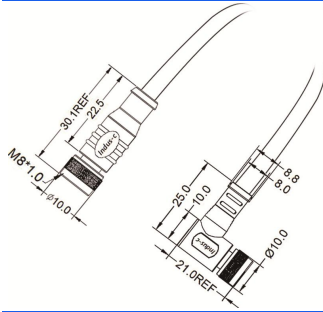

Part number/产品料号

Pins/针数	Code/型	Part number("X" is length millimetre mm)/产品料号("X"表示长度, 单位毫米mm)			
		PVC jacket/PVC外被		PUR jacket/PUR外被	
		-10°C~+80°C	-40°C~+105°C	-40°C~+105°C	
3pins/3孔	A code/A型	8L00178-X	8L00179-X	8L00180-X	
4pins/4孔	A code/A型	8L00236-X	8L00237-X	8L00238-X	
6pins/6孔	A code/A型	8L00352-X	8L00353-X	8L00354-X	
8pins/8孔	A code/A型	8L00412-X	8L00413-X	8L00414-X	
5pins/5孔	B code/B型	8L00293-X	8L00294-X	8L00295-X	
4pins/4针	D code/D型	8L00565-X	8L00566-X	8L00567-X	

Pin assignment front view/孔位分布前视图

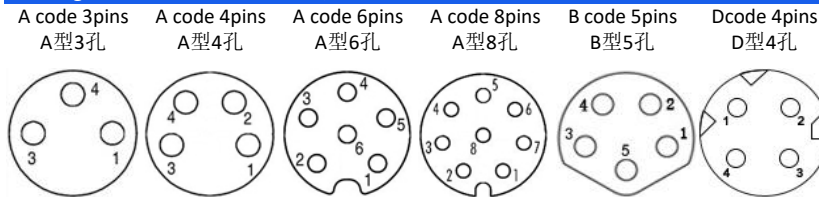

General data/常规数据

Pin numbers/孔数	3pins/3孔	4pins/4孔	5pins/5孔	6pins/6孔	8pins/8孔
Rated voltage/额定电压	60V	30V	30V	30V	30V
Rated current(40°C)/额定电流	3A	3A	3A	1A	1A
Standards/标准	IEC 61076-2-104				
Termination/焊接方式	Solder and over-mold/焊接和成型				
Connector locking system/锁紧方式	Screw/螺锁				
Degree of protection/防护等级	IP67, IP68, IP69K				
Wire gauge(mm²)/线规(平方数)	0.14mm²-0.34mm²			0.14mm²	
Wire gauge(AWG)/线号(平方数)	26AWG-22AWG			26AWG	
Mechanical operation/插拔次数	>100 mating cycles/大于100次				
Ambient temperature(operation)/操作温度	-25°C~+85°C				
Contact resistance/接触电阻	≤5mΩ				
Insulation resistance/绝缘电阻	≥100MΩ				
Connector body/胶芯	TPU				
Pin/端子	Phosphorus copper with gold plated/磷铜镀金				
Screw/螺丝	Brass with nickel plated/黄铜镀镍				
Over-mold/成型	TPU				
Gasket/胶圈	Fluorine ring/氟胶圈				
Customs tariff number/海关编码	8518900001				
Environmental compliance/环境符合标准	RoHS, Reach				

M8 code female to female straight molded cable, unshielded/M8母头直头对母头直头连接线, 不带屏蔽

Scale drawing/尺寸图

Product photo/产品图

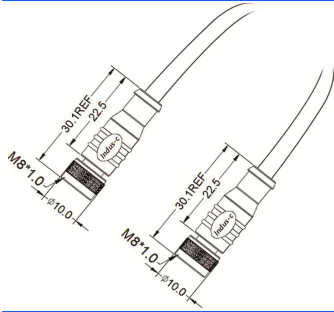

Part number/产品料号

Pins/针数	Code/型	Part number("X" is length millimetre mm)/产品料号("X"表示长度, 单位毫米mm)			
		PVC jacket/PVC外被		PUR jacket/PUR外被	
		-10°C~+80°C	-40°C~+105°C	-40°C~+105°C	
3pins/3孔	A code/A型	8L00175-X	8L00176-X	8L00177-X	
4pins/4孔	A code/A型	8L00233-X	8L00234-X	8L00235-X	
6pins/6孔	A code/A型	8L00349-X	8L00350-X	8L00351-X	
8pins/8孔	A code/A型	8L00409-X	8L00410-X	8L00411-X	
5pins/5孔	B code/B型	8L00290-X	8L00291-X	8L00292-X	
4pins/4针	D code/D型	8L00568-X	8L00569-X	8L00570-X	

Pin assignment front view/孔位分布前视图

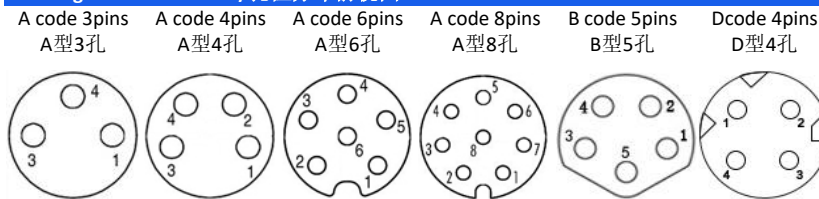

General data/常规数据

Pin numbers/孔数	3pins/3孔	4pins/4孔	5pins/5孔	6pins/6孔	8pins/8孔
Rated voltage/额定电压	60V	30V	30V	30V	30V
Rated current(40°C)/额定电流	3A	3A	3A	1A	1A
Standards/标准	IEC 61076-2-104				
Termination/焊接方式	Solder and over-mold/焊接和成型				
Connector locking system/锁紧方式	Screw/螺锁				
Degree of protection/防护等级	IP67, IP68, IP69K				
Wire gauge(mm²)/线规(平方数)	0.14mm²-0.34mm²			0.14mm²	
Wire gauge(AWG)/线号(平方数)	26AWG-22AWG			26AWG	
Mechanical operation/插拔次数	>100 mating cycles/大于100次				
Ambient temperature(operation)/操作温度	-25°C~+85°C				
Contact resistance/接触电阻	≤5mΩ				
Insulation resistance/绝缘电阻	≥100MΩ				
Connector body/胶芯	TPU				
Pin/端子	Phosphorus copper with gold plated/磷铜镀金				
Screw/螺丝	Brass with nickel plated/黄铜镀镍				
Over-mold/成型	TPU				
Gasket/胶圈	Fluorine ring/氟胶圈				
Customs tariff number/海关编码	8518900001				
Environmental compliance/环境符合标准	RoHS, Reach				

M8 code male to male right angle molded cable, shielded/M8公头弯头对公头弯头连接线, 带屏蔽

Scale drawing/尺寸图

Product photo/产品图

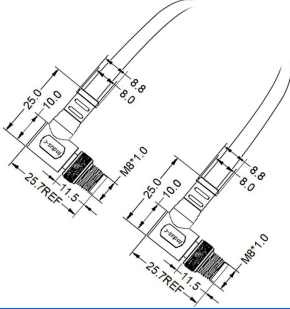

Part number/产品料号

Pins/针数	Code/型	Part number("X" is length millimetre mm)/产品料号("X"表示长度, 单位毫米mm)			
		PVC jacket/PVC外被		PUR jacket/PUR外被	
		-10°C~+80°C	-40°C~+105°C	-40°C~+105°C	
3pins/3孔	A code/A型	8L00018-X	8L00210-X	8L00211-X	
4pins/4孔	A code/A型	8L00266-X	8L00267-X	8L00268-X	
6pins/6孔	A code/A型	8L00385-X	8L00386-X	8L00387-X	
8pins/8孔	A code/A型	8L00445-X	8L00446-X	8L00447-X	
5pins/5孔	B code/B型	8L00326-X	8L00327-X	8L00328-X	
4pins/4针	D code/D型	8L00571-X	8L00572-X	8L00573-X	

Pin assignment front view/孔位分布前视图

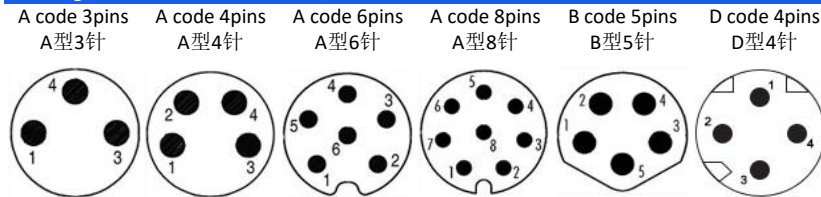

General data/常规数据

Pin numbers/孔数	3pins/3孔	4pins/4孔	5pins/5孔	6pins/6孔	8pins/8孔
Rated voltage/额定电压	60V	30V	30V	30V	30V
Rated current(40°C)/额定电流	3A	3A	3A	1A	1A
Standards/标准	IEC 61076-2-104				
Termination/焊接方式	Solder and over-mold/焊接和成型				
Connector locking system/锁紧方式	Screw/螺锁				
Degree of protection/防护等级	IP67, IP68, IP69K				
Wire gauge(mm²)/线规(平方数)	0.14mm²-0.34mm²			0.14mm²	
Wire gauge(AWG)/线号(平方数)	26AWG-22AWG			26AWG	
Mechanical operation/插拔次数	>100 mating cycles/大于100次				
Ambient temperature(operation)/操作温度	-25°C~+85°C				
Contact resistance/接触电阻	≤5mΩ				
Insulation resistance/绝缘电阻	≥100MΩ				
Connector body/胶芯	TPU				
Pin/端子	Brass with gold plated/黄铜镀金				
Screw/螺丝	Brass with nickel plated/黄铜镀镍				
Over-mold/成型	TPU				
Gasket/胶圈	Fluorine ring/氟胶圈				
Customs tariff number/海关编码	8518900001				
Environmental compliance/环境符合标准	RoHS, Reach				

M8 male to female right angle molded cable, shielded/M8公对母弯头成型式连接线, 带屏蔽

Scale drawing/尺寸图

Product photo/产品图

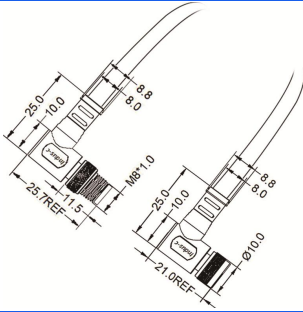

Part number/产品料号

Pins/针数	Code/型	Part number("X" is length millimetre mm)/产品料号("X"表示长度, 单位毫米mm)			
		PVC jacket/PVC外被		PUR jacket/PUR外被	
		-10°C~+80°C	-40°C~+105°C	-40°C~+105°C	
3pins/3孔	A code/A型	8L00189-X	8L00190-X	8L00191-X	
4pins/4孔	A code/A型	8L00247-X	8L00248-X	8L00249-X	
6pins/6孔	A code/A型	8L00364-X	8L00365-X	8L00366-X	
8pins/8孔	A code/A型	8L00424-X	8L00425-X	8L00426-X	
5pins/5孔	B code/B型	8L00305-X	8L00306-X	8L00307-X	
4pins/4针	D code/D型	8L00574-X	8L00575-X	8L00576-X	

Pin assignment front view/孔位分布前视图

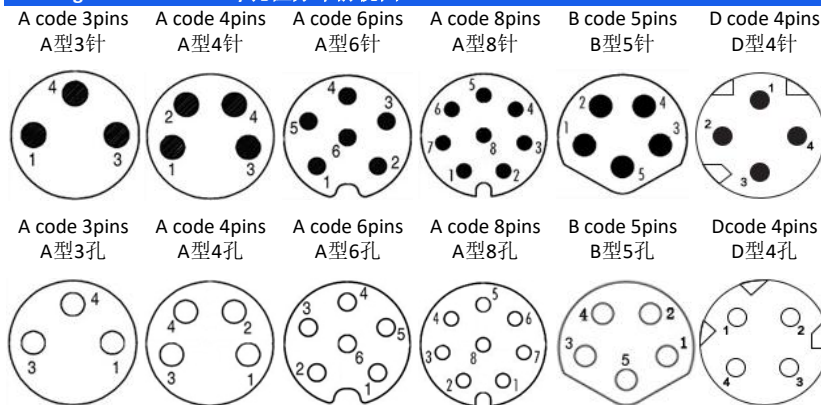

General data/常规数据

Pin numbers/孔数	3pins/3孔	4pins/4孔	5pins/5孔	6pins/6孔	8pins/8孔
Rated voltage/额定电压	60V	30V	30V	30V	30V
Rated current(40°C)/额定电流	3A	3A	3A	1A	1A
Standards/标准	IEC 61076-2-104				
Termination/焊接方式	Solder and over-mold/焊接和成型				
Connector locking system/锁紧方式	Screw/螺锁				
Degree of protection/防护等级	IP67, IP68, IP69K				
Wire gauge(mm²)/线规(平方数)	0.14mm²-0.34mm²			0.14mm²	
Wire gauge(AWG)/线号(平方数)	26AWG-22AWG			26AWG	
Mechanical operation/插拔次数	>100 mating cycles/大于100次				
Ambient temperature(operation)/操作温度	-25°C~+85°C				
Contact resistance/接触电阻	≤5mΩ				
Insulation resistance/绝缘电阻	≥100MΩ				
Connector body/胶芯	TPU				
Male pin/公端子	Brass with gold plated/黄铜镀金				
Female pin/母端子	Phosphorus copper with gold plated/磷铜镀金				
Screw/螺丝	Brass with nickel plated/黄铜镀镍				
Customs tariff number/海关编码	8518900001				
Environmental compliance/环境符合标准	RoHs, Reach				

M8 male right angle to female straight molded cable, shielded/M8公头弯头对母头直头成型式连接线, 带屏蔽

Scale drawing/尺寸图

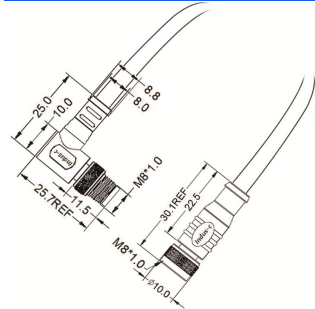

Product photo/产品图



Part number/产品料号

Pins/针数	Code/型	Part number("X" is length millimetre mm)/产品料号("X"表示长度, 单位毫米mm)			
		PVC jacket/PVC外被		PUR jacket/PUR外被	
		-10°C~+80°C	-40°C~+105°C	-40°C~+105°C	
3pins/3孔	A code/A型	8L00195-X	8L00196-X	8L00197-X	
4pins/4孔	A code/A型	8L00253-X	8L00254-X	8L00255-X	
6pins/6孔	A code/A型	8L00370-X	8L00371-X	8L00372-X	
8pins/8孔	A code/A型	8L00430-X	8L00431-X	8L00432-X	
5pins/5孔	B code/B型	8L00311-X	8L00312-X	8L00313-X	
4pins/4针	D code/D型	8L00577-X	8L00578-X	8L00579-X	

Pin assignment front view/孔位分布前视图

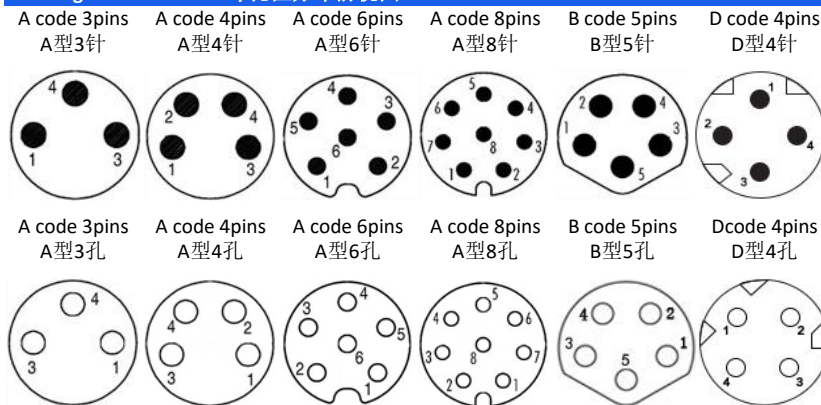

General data/常规数据

Pin numbers/孔数	3pins/3孔	4pins/4孔	5pins/5孔	6pins/6孔	8pins/8孔
Rated voltage/额定电压	60V	30V	30V	30V	30V
Rated current(40°C)/额定电流	3A	3A	3A	1A	1A
Standards/标准	IEC 61076-2-104				
Connector locking system/锁紧方式	Screw/螺锁				
Degree of protection/防护等级	IP67, IP68, IP69K				
Wire gauge(mm²)/线规(平方数)	0.14mm²-0.34mm²			0.14mm²	
Wire gauge(AWG)/线号(平方数)	26AWG-22AWG			26AWG	
Mechanical operation/插拔次数	>100 mating cycles/大于100次				
Ambient temperature(operation)/操作温度	-25°C~+85°C				
Contact resistance/接触电阻	≤5mΩ				
Insulation resistance/绝缘电阻	≥100MΩ				
Connector body/胶芯	TPU				
Male pin/公端子	Brass with gold plated/黄铜镀金				
Female pin/母端子	Phosphorus copper with gold plated/磷铜镀金				
Screw/螺丝	Brass with nickel plated/黄铜镀镍				
Shielded sheath/屏蔽罩	Brass with nickel plated/黄铜镀镍				
Customs tariff number/海关编码	8518900001				
Environmental compliance/环境符合标准	RoHS, Reach				

M8 code male straight to male right angle molded cable, shielded/M8公头直头对公头弯头连接线, 带屏蔽

Scale drawing/尺寸图

Product photo/产品图

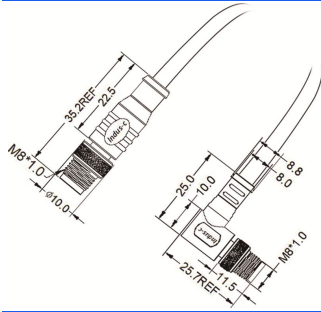

Part number/产品料号

Pins/针数	Code/型	Part number("X" is length millimetre mm)/产品料号("X"表示长度, 单位毫米mm)			
		PVC jacket/PVC外被		PUR jacket/PUR外被	
		-10°C~+80°C	-40°C~+105°C	-40°C~+105°C	
3pins/3孔	A code/A型	8L00201-X	8L00202-X	8L00203-X	
4pins/4孔	A code/A型	8L00257-X	8L00258-X	8L00259-X	
6pins/6孔	A code/A型	8L00376-X	8L00377-X	8L00378-X	
8pins/8孔	A code/A型	8L00436-X	8L00437-X	8L00438-X	
5pins/5孔	B code/B型	8L00317-X	8L00318-X	8L00319-X	
4pins/4针	D code/D型	8L00580-X	8L00581-X	8L00582-X	

Pin assignment front view/孔位分布前视图

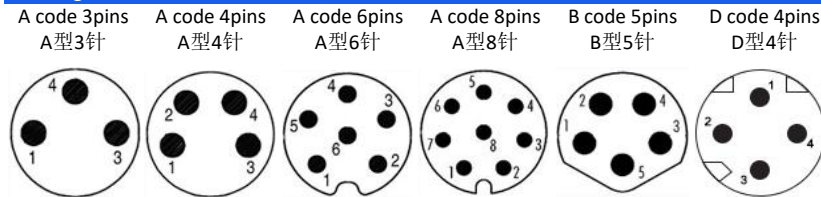

General data/常规数据

Pin numbers/孔数	3pins/3孔	4pins/4孔	5pins/5孔	6pins/6孔	8pins/8孔
Rated voltage/额定电压	60V	30V	30V	30V	30V
Rated current(40°C)/额定电流	3A	3A	3A	1A	1A
Standards/标准	IEC 61076-2-104				
Termination/焊接方式	Solder and over-mold/焊接和成型				
Connector locking system/锁紧方式	Screw/螺锁				
Degree of protection/防护等级	IP67, IP68, IP69K				
Wire gauge(mm²)/线规(平方数)	0.14mm²-0.34mm²			0.14mm²	
Wire gauge(AWG)/线号(平方数)	26AWG-22AWG			26AWG	
Mechanical operation/插拔次数	>100 mating cycles/大于100次				
Ambient temperature(operation)/操作温度	-25°C~+85°C				
Contact resistance/接触电阻	≤5mΩ				
Insulation resistance/绝缘电阻	≥100MΩ				
Connector body/胶芯	TPU				
Pin/端子	Brass with gold plated/黄铜镀金				
Screw/螺丝	Brass with nickel plated/黄铜镀镍				
Over-mold/成型	TPU				
Gasket/胶圈	Fluorine ring/氟胶圈				
Customs tariff number/海关编码	8518900001				
Environmental compliance/环境符合标准	RoHS, Reach				

M8 code male to male straight molded cable, shielded/M8公头直头对公头直头连接线, 带屏蔽

Scale drawing/尺寸图

Product photo/产品图

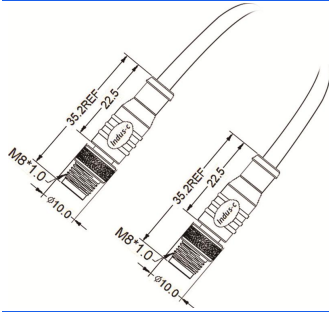

Part number/产品料号

Pins/针数	Code/型	Part number("X" is length millimetre mm)/产品料号("X"表示长度, 单位毫米mm)			
		PVC jacket/PVC外被		PUR jacket/PUR外被	
		-10°C~+80°C	-40°C~+105°C	-40°C~+105°C	
3pins/3孔	A code/A型	8L00198-X	8L00199-X	8L00200-X	
4pins/4孔	A code/A型	8L00044-X	8L00043-X	8L00256-X	
6pins/6孔	A code/A型	8L00373-X	8L00374-X	8L00375-X	
8pins/8孔	A code/A型	8L00433-X	8L00434-X	8L00435-X	
5pins/5孔	B code/B型	8L00314-X	8L00315-X	8L00316-X	
4pins/4针	D code/D型	8L00583-X	8L00584-X	8L00585-X	

Pin assignment front view/孔位分布前视图

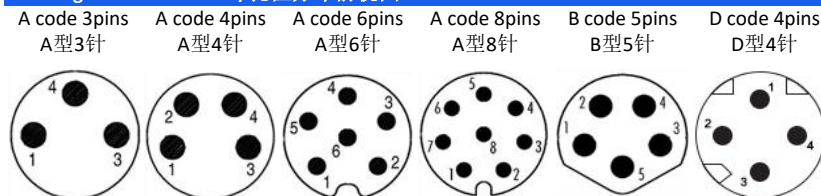

General data/常规数据

Pin numbers/孔数	3pins/3孔	4pins/4孔	5pins/5孔	6pins/6孔	8pins/8孔
Rated voltage/额定电压	60V	30V	30V	30V	30V
Rated current(40°C)/额定电流	3A	3A	3A	1A	1A
Standards/标准	IEC 61076-2-104				
Termination/焊接方式	Solder and over-mold/焊接和成型				
Connector locking system/锁紧方式	Screw/螺锁				
Degree of protection/防护等级	IP67, IP68, IP69K				
Wire gauge(mm²)/线规(平方数)	0.14mm²-0.34mm²			0.14mm²	
Wire gauge(AWG)/线号(平方数)	26AWG-22AWG			26AWG	
Mechanical operation/插拔次数	>100 mating cycles/大于100次				
Ambient temperature(operation)/操作温度	-25°C~+85°C				
Contact resistance/接触电阻	≤5mΩ				
Insulation resistance/绝缘电阻	≥100MΩ				
Connector body/胶芯	TPU				
Pin/端子	Brass with gold plated/黄铜镀金				
Screw/螺丝	Brass with nickel plated/黄铜镀镍				
Over-mold/成型	TPU				
Gasket/胶圈	Fluorine ring/氟胶圈				
Customs tariff number/海关编码	8518900001				
Environmental compliance/环境符合标准	RoHS, Reach				

M8 male straight to female right angle molded cable, shielded/M8公头直头对母头弯头成型式连接线, 带屏蔽

Scale drawing/尺寸图

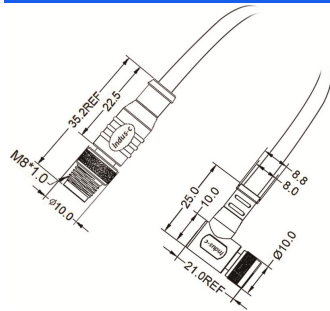

Product photo/产品图



Part number/产品料号

Pins/针数	Code/型	Part number("X" is length millimetre mm)/产品料号("X"表示长度, 单位毫米mm)			
		PVC jacket/PVC外被		PUR jacket/PUR外被	
		-10°C~+80°C	-40°C~+105°C	-40°C~+105°C	
3pins/3孔	A code/A型	8L00037-X	8L00164-X	8L00165-X	
4pins/4孔	A code/A型	8L00221-X	8L00222-X	8L00223-X	
6pins/6孔	A code/A型	8L00337-X	8L00338-X	8L00339-X	
8pins/8孔	A code/A型	8L00397-X	8L00398-X	8L00399-X	
5pins/5孔	B code/B型	8L00278-X	8L00279-X	8L00280-X	
4pins/4针	D code/D型	8L00586-X	8L00587-X	8L00588-X	

Pin assignment front view/孔位分布前视图

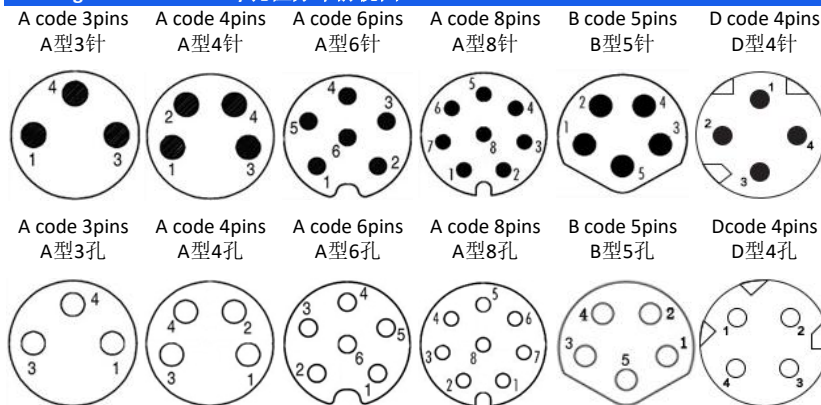

General data/常规数据

Pin numbers/孔数	3pins/3孔	4pins/4孔	5pins/5孔	6pins/6孔	8pins/8孔
Rated voltage/额定电压	60V	30V	30V	30V	30V
Rated current(40°C)/额定电流	3A	3A	3A	1A	1A
Standards/标准	IEC 61076-2-104				
Connector locking system/锁紧方式	Screw/螺锁				
Degree of protection/防护等级	IP67, IP68, IP69K				
Wire gauge(mm²)/线规(平方数)	0.14mm²-0.34mm²			0.14mm²	
Wire gauge(AWG)/线号(平方数)	26AWG-22AWG			26AWG	
Mechanical operation/插拔次数	>100 mating cycles/大于100次				
Ambient temperature(operation)/操作温度	-25°C~+85°C				
Contact resistance/接触电阻	≤5mΩ				
Insulation resistance/绝缘电阻	≥100MΩ				
Connector body/胶芯	TPU				
Male pin/公端子	Brass with gold plated/黄铜镀金				
Female pin/母端子	Phosphorus copper with gold plated/磷铜镀金				
Screw/螺丝	Brass with nickel plated/黄铜镀镍				
Over-mold/成型	TPU				
Customs tariff number/海关编码	8518900001				

M8 male to female straight molded cable, shielded/M8公对母直头成型式连接线, 带屏蔽

Scale drawing/尺寸图

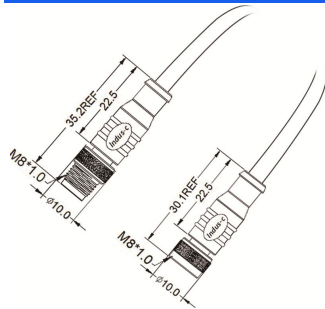

Product photo/产品图



Part number/产品料号

Pins/针数	Code/型	Part number("X" is length millimetre mm)/产品料号("X"表示长度, 单位毫米mm)			
		PVC jacket/PVC外被		PUR jacket/PUR外被	
		-10°C~+80°C	-40°C~+105°C	-40°C~+105°C	
3pins/3孔	A code/A型	8L00186-X	8L00187-X	8L00188-X	
4pins/4孔	A code/A型	8L00245-X	8L00246-X	8L00050-X	
6pins/6孔	A code/A型	8L00361-X	8L00362-X	8L00363-X	
8pins/8孔	A code/A型	8L00421-X	8L00422-X	8L00423-X	
5pins/5孔	B code/B型	8L00302-X	8L00303-X	8L00304-X	
4pins/4针	D code/D型	8L00589-X	8L00590-X	8L00591-X	

Pin assignment front view/孔位分布前视图

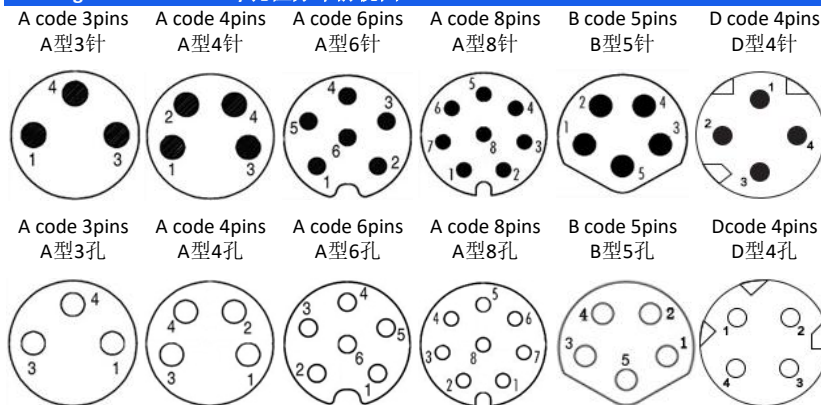

General data/常规数据

Pin numbers/孔数	3pins/3孔	4pins/4孔	5pins/5孔	6pins/6孔	8pins/8孔
Rated voltage/额定电压	60V	30V	30V	30V	30V
Rated current(40°C)/额定电流	3A	3A	3A	1A	1A
Standards/标准	IEC 61076-2-104				
Connector locking system/锁紧方式	Screw/螺锁				
Degree of protection/防护等级	IP67, IP68, IP69K				
Wire gauge(mm²)/线规(平方数)	0.14mm²-0.34mm²			0.14mm²	
Wire gauge(AWG)/线号(平方数)	26AWG-22AWG			26AWG	
Mechanical operation/插拔次数	>100 mating cycles/大于100次				
Ambient temperature(operation)/操作温度	-25°C~+85°C				
Contact resistance/接触电阻	≤5mΩ				
Insulation resistance/绝缘电阻	≥100MΩ				
Connector body/胶芯	TPU				
Male pin/公端子	Brass with gold plated/黄铜镀金				
Female pin/母端子	Phosphorus copper with gold plated/磷铜镀金				
Screw/螺丝	Brass with nickel plated/黄铜镀镍				
Shielded sheill/屏蔽罩	Brass with nickel plated/黄铜镀镍				
Customs tariff number/海关编码	8518900001				
Environmental compliance/环境符合标准	RoHS, Reach				

M8 code female to female right angle molded cable, shielded/M8母头弯头对母头弯头连接线, 带屏蔽

Scale drawing/尺寸图

Product photo/产品图

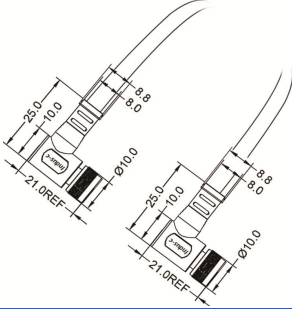

Part number/产品料号

Pins/针数	Code/型	Part number("X" is length millimetre mm)/产品料号("X"表示长度, 单位毫米mm)			
		PVC jacket/PVC外被		PUR jacket/PUR外被	
		-10°C~+80°C	-40°C~+105°C	-40°C~+105°C	
3pins/3孔	A code/A型	8L00212-X	8L00213-X	8L00214-X	
4pins/4孔	A code/A型	8L00269-X	8L00270-X	8L00271-X	
6pins/6孔	A code/A型	8L00388-X	8L00389-X	8L00390-X	
8pins/8孔	A code/A型	8L00448-X	8L00449-X	8L00450-X	
5pins/5孔	B code/B型	8L00329-X	8L00330-X	8L00331-X	
4pins/4针	D code/D型	8L00592-X	8L00593-X	8L00594-X	

Pin assignment front view/孔位分布前视图

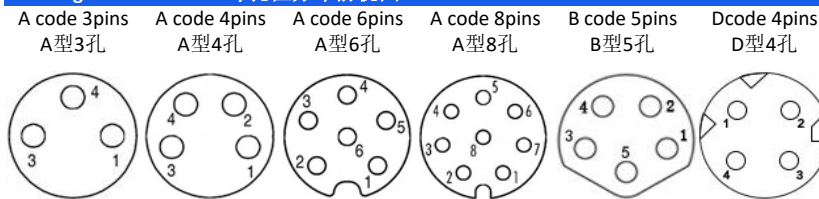

General data/常规数据

Pin numbers/孔数	3pins/3孔	4pins/4孔	5pins/5孔	6pins/6孔	8pins/8孔
Rated voltage/额定电压	60V	30V	30V	30V	30V
Rated current(40°C)/额定电流	3A	3A	3A	1A	1A
Standards/标准	IEC 61076-2-104				
Termination/焊接方式	Solder and over-mold/焊接和成型				
Connector locking system/锁紧方式	Screw/螺锁				
Degree of protection/防护等级	IP67, IP68, IP69K				
Wire gauge(mm²)/线规(平方数)	0.14mm²-0.34mm²			0.14mm²	
Wire gauge(AWG)/线号(平方数)	26AWG-22AWG			26AWG	
Mechanical operation/插拔次数	>100 mating cycles/大于100次				
Ambient temperature(operation)/操作温度	-25°C~+85°C				
Contact resistance/接触电阻	≤5mΩ				
Insulation resistance/绝缘电阻	≥100MΩ				
Connector body/胶芯	TPU				
Pin/端子	Phosphorus copper with gold plated/磷铜镀金				
Screw/螺丝	Brass with nickel plated/黄铜镀镍				
Over-mold/成型	TPU				
Gasket/胶圈	Fluorine ring/氟胶圈				
Customs tariff number/海关编码	8518900001				
Environmental compliance/环境符合标准	RoHS, Reach				

M8 code female straight to female right angle molded cable, shielded/M8母头直头对母头弯头连接线, 带屏蔽

Scale drawing/尺寸图

Product photo/产品图

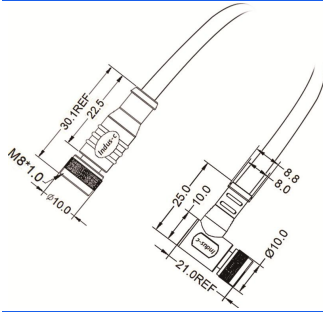

Part number/产品料号

Pins/针数	Code/型	Part number("X" is length millimetre mm)/产品料号("X"表示长度, 单位毫米mm)			
		PVC jacket/PVC外被		PUR jacket/PUR外被	
		-10°C~+80°C	-40°C~+105°C	-40°C~+105°C	
3pins/3孔	A code/A型	8L00207-X	8L00208-X	8L00209-X	
4pins/4孔	A code/A型	8L00263-X	8L00264-X	8L00265-X	
6pins/6孔	A code/A型	8L00382-X	8L00383-X	8L00384-X	
8pins/8孔	A code/A型	8L00442-X	8L00443-X	8L00444-X	
5pins/5孔	B code/B型	8L00323-X	8L00324-X	8L00325-X	
4pins/4针	D code/D型	8L00595-X	8L00596-X	8L00597-X	

Pin assignment front view/孔位分布前视图

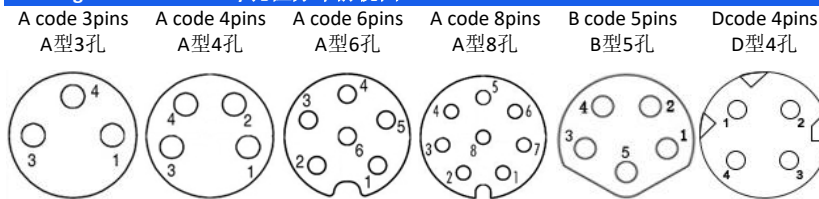

General data/常规数据

Pin numbers/孔数	3pins/3孔	4pins/4孔	5pins/5孔	6pins/6孔	8pins/8孔
Rated voltage/额定电压	60V	30V	30V	30V	30V
Rated current(40°C)/额定电流	3A	3A	3A	1A	1A
Standards/标准	IEC 61076-2-104				
Termination/焊接方式	Solder and over-mold/焊接和成型				
Connector locking system/锁紧方式	Screw/螺锁				
Degree of protection/防护等级	IP67, IP68, IP69K				
Wire gauge(mm²)/线规(平方数)	0.14mm²-0.34mm²			0.14mm²	
Wire gauge(AWG)/线号(平方数)	26AWG-22AWG			26AWG	
Mechanical operation/插拔次数	>100 mating cycles/大于100次				
Ambient temperature(operation)/操作温度	-25°C~+85°C				
Contact resistance/接触电阻	≤5mΩ				
Insulation resistance/绝缘电阻	≥100MΩ				
Connector body/胶芯	TPU				
Pin/端子	Phosphorus copper with gold plated/磷铜镀金				
Screw/螺丝	Brass with nickel plated/黄铜镀镍				
Over-mold/成型	TPU				
Gasket/胶圈	Fluorine ring/氟胶圈				
Customs tariff number/海关编码	8518900001				
Environmental compliance/环境符合标准	RoHS, Reach				

M8 code female to female straight molded cable, shielded/M8母头直头对母头直头连接线, 带屏蔽

Scale drawing/尺寸图

Product photo/产品图

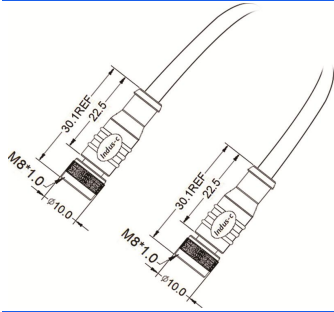

Part number/产品料号

Pins/针数	Code/型	Part number("X" is length millimetre mm)/产品料号("X"表示长度, 单位毫米mm)			
		PVC jacket/PVC外被		PUR jacket/PUR外被	
		-10°C~+80°C	-40°C~+105°C	-40°C~+105°C	
3pins/3孔	A code/A型	8L00204-X	8L00205-X	8L00206-X	
4pins/4孔	A code/A型	8L00260-X	8L00261-X	8L00262-X	
6pins/6孔	A code/A型	8L00379-X	8L00380-X	8L00381-X	
8pins/8孔	A code/A型	8L00439-X	8L00440-X	8L00441-X	
5pins/5孔	B code/B型	8L00320-X	8L00321-X	8L00322-X	
4pins/4针	D code/D型	8L00598-X	8L00599-X	8L00600-X	

Pin assignment front view/孔位分布前视图

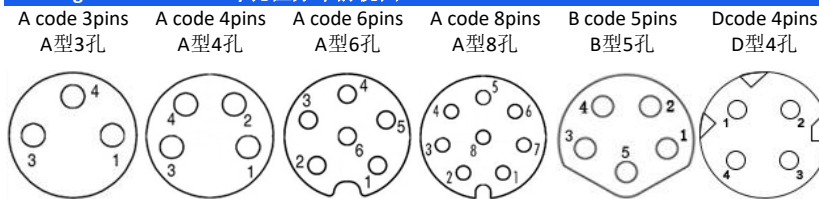

General data/常规数据

Pin numbers/孔数	3pins/3孔	4pins/4孔	5pins/5孔	6pins/6孔	8pins/8孔
Rated voltage/额定电压	60V	30V	30V	30V	30V
Rated current(40°C)/额定电流	3A	3A	3A	1A	1A
Standards/标准	IEC 61076-2-104				
Termination/焊接方式	Solder and over-mold/焊接和成型				
Connector locking system/锁紧方式	Screw/螺锁				
Degree of protection/防护等级	IP67, IP68, IP69K				
Wire gauge(mm²)/线规(平方数)	0.14mm²-0.34mm²			0.14mm²	
Wire gauge(AWG)/线号(平方数)	26AWG-22AWG			26AWG	
Mechanical operation/插拔次数	>100 mating cycles/大于100次				
Ambient temperature(operation)/操作温度	-25°C~+85°C				
Contact resistance/接触电阻	≤5mΩ				
Insulation resistance/绝缘电阻	≥100MΩ				
Connector body/胶芯	TPU				
Pin/端子	Phosphorus copper with gold plated/磷铜镀金				
Screw/螺丝	Brass with nickel plated/黄铜镀镍				
Over-mold/成型	TPU				
Gasket/胶圈	Fluorine ring/氟胶圈				
Customs tariff number/海关编码	8518900001				
Environmental compliance/环境符合标准	RoHS, Reach				